

YOUR
OWN
STYLE

SOPRAVASCA



H135 *	3mm *
H140	6mm

Finiture / Finishes / Acabados / Finitions / Afwerkingen / Ausführungen

Telaio / Frame / Bastidor / Profilé / Frame / Rahmen



Vetro / Glass / Vidrio / Verre / Glas / Glas

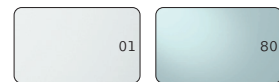

Modelli / Models / Modelos / Modèles / Modellen / Modelle

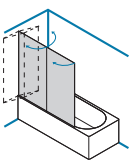

Telaio / Frame
Bastidor / Profilé
Frame / Rahmen:
AN - AC - WM - BM

Vetro / Glass
Vidrio / Verre
Glas / Glas:
01

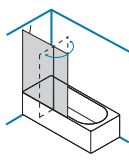

Telaio / Frame
Bastidor / Profilé
Frame / Rahmen:
AN - WZ

Vetro / Glass
Vidrio / Verre
Glas / Glas:
01 - 80

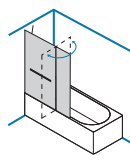

Telaio / Frame
Bastidor / Profilé
Frame / Rahmen:
AN - WZ

Vetro / Glass
Vidrio / Verre
Glas / Glas:
01 - 80

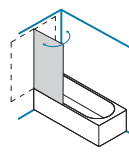

Telaio / Frame
Bastidor / Profilé
Frame / Rahmen:
AN - WZ - BM

Vetro / Glass
Vidrio / Verre
Glas / Glas:
01 - 80

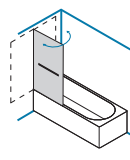

Telaio / Frame
Bastidor / Profilé
Frame / Rahmen:
AN - WZ

Vetro / Glass
Vidrio / Verre
Glas / Glas:
01 - 80

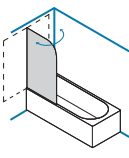

Telaio / Frame
Bastidor / Profilé
Frame / Rahmen:
AN - WZ - AA

Vetro / Glass
Vidrio / Verre
Glas / Glas:
01

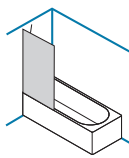

Telaio / Frame
Bastidor / Profilé
Frame / Rahmen:
AN

Vetro / Glass
Vidrio / Verre
Glas / Glas:
01

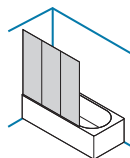

Telaio / Frame
Bastidor / Profilé
Frame / Rahmen:
WZ

Vetro / Glass
Vidrio / Verre
Glas / Glas:
01



www.inda.net

inda[®]
bathroom interiors

**ŞOPRAVASCA / BATHSCREENS
ÉCRANS DE BAIGNOIRE / MAMPARAS DE BAÑERA
BADSCHERMEN / BADEWANNENAUFSATZ**

H140

6mm



Le dimensioni sono in mm / Sizes in mm /
Les dimensions sont indiquées en mm /
Las medidas son en mm /
De afmetingen zijn vermeld in mm / Maßangaben in mm

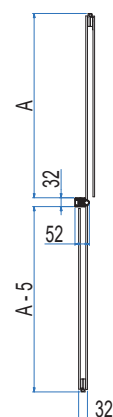
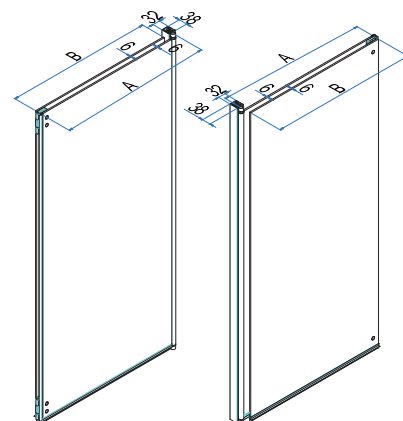
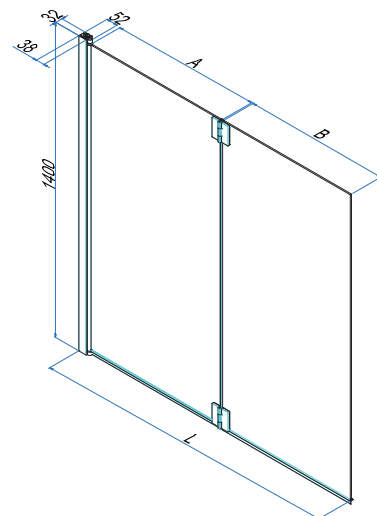

Apertura mediante sistema Camme integrato. Apertura totale delle ante sia verso l'interno che verso l'esterno.
Opening with integrated Camme-Sytem Fulldoor opening internally and externally.
Ouverture grâce à une articulation à Came intégrée. Ouverture totale des portes aussi bien à l'intérieure que à l'extérieur.
Apertura mediante sistemas integrados Camme. Apertura total de las puertas tanto hacia el interior como hacia el exterior.
Opening d.m.v. geïntegreerde Camme systemen. Totale opening van de deuren zowel naar buiten als naar binnen toe.
Öffnung erfolgt durch integriertes Camme-System. Totale Türöffnung nach Innen als auch nach Aussen möglich.

Cod.	L	K	KG	
BPL140	100 cm	48	30	1
BPL160	120 cm	58	35	1
BPL180	140 cm	68	40	1

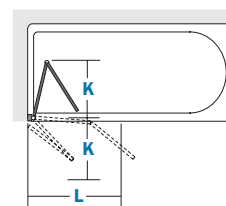

Sopravasca orientabile a due ante / Adjustable bathscreen with two panels
Écran de baignoire orientable à deux volets / Mampara de bañera orientable con dos hojas
Draaibaar badscherm met twee deuren / Schwenkbarer Badewannenaufsatz mit 2 Teiliger

H max 160cm
L min 80cm/max 140cm

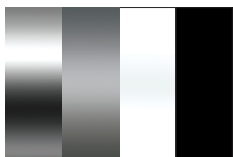

AN AC WM BM



01

Larghezza - estensibilità
 Breadth - extensibility
 Largeur - extensibilité
 Composición - extensibilidad
 Breedte - aanpassingsvermogen
 Breite - Anpassungsfähigkeit

cod.

L 100 cm

BPL140 AN 01
BPL140 AC 01
BPL140 WM 01
BPL140 BM 01

L 120 cm

BPL160 AN 01
BPL160 AC 01
BPL160 WM 01
BPL160 BM 01

L 140 cm

BPL180 AN 01
BPL180 AC 01
BPL180 WM 01
BPL180 BM 01

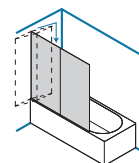

**SOPRAVASCA / BATHSCREENS
ÉCRANS DE BAIGNOIRE / MAMPARAS DE BAÑERA
BADSCHERMEN / BADEWANNENAUFSATZ**

Le dimensioni sono in mm / Sizes in mm /
Les dimensions sont indiquées en mm /
Las medidas son en mm /
De afmetingen zijn vermeld in mm / Maßangaben in mm

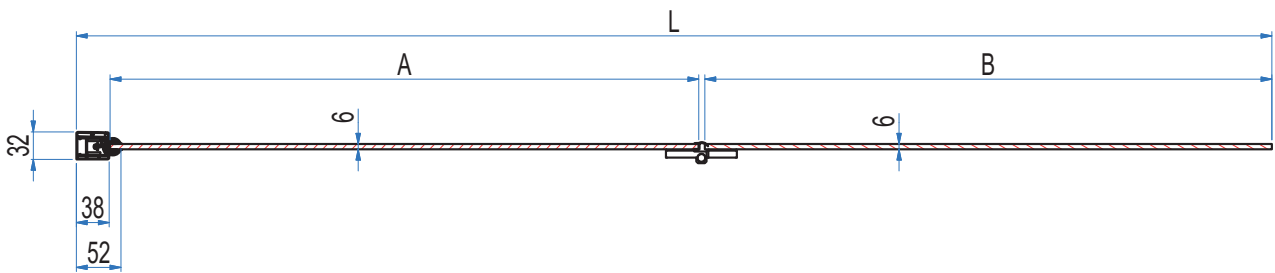

Le dimensioni sono in mm / Sizes in mm /
Les dimensions sont indiquées en mm /
Las medidas son en mm /
De afmetingen zijn vermeld in mm / Maßangaben in mm