

YOUR
OWN
STYLE



AZURE

The new dimension of shower space.



H200

8mm

Finiture / Finishes / Acabados / Finitions / Afwerkingen / Ausführungen

Telaio / Frame / Bastidor / Profilé / Frame / Rahmen



Vetro / Glass / Vidrio / Verre / Glas / Glas

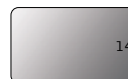
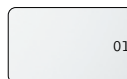

Modelli / Models / Modelos / Modèles / Modellen / Modelle

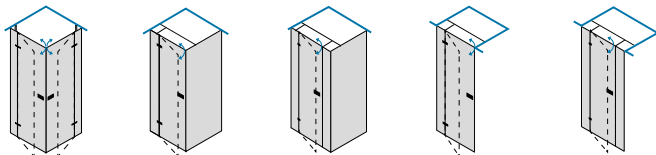

www.inda.net

 **inda**[®]
bathroom interiors



Le dimensioni sono in mm / Sizes in mm /
 Les dimensions sont indiquées en mm /
 Las medidas son en mm /
 De afmetingen zijn vermeld in mm / Maßangaben in mm

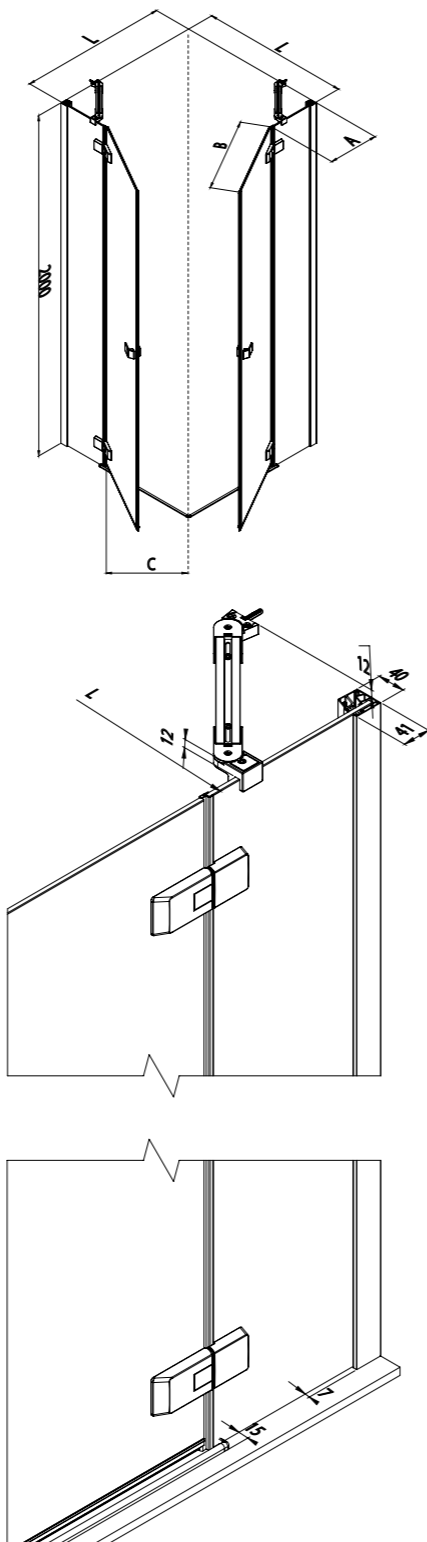

Chiusura magnetica. Apertura totale delle ante sia verso l'interno che verso l'esterno. Guarnizione inferiore. Maniglia inclusa. Nell'imballo sono incluse due guarnizioni per installazione con o senza frangiflutto. Magnetic closure. Fulldoor opening internally and externally. Bottom strip. Handle included. In the packaging two seals for installation with or without water brake are included. Fermeture magnétique. Ouverture totale des portes aussi bien à l'intérieur que à l'extérieur. Joint inférieur. Poignée incluse. Dans l'emballage sont compris deux joints pour l'installation avec ou sans brise-flux. Cierre magnético. Apertura total de la puerta interna y externa. Junta inferior. Tirador incluido. En el embalaje están incluidas dos guarniciones para instalación con o sin rompeolas. Magnetische sluiting. Totale opening van de deuren zowel naar buiten als naar binnen toe. Onderstrip. Inclusief greep. In de verpakking zijn twee dichtingen inbegrepen, voor de installatie met of zonder de golfbreker. Magnetverschluss. Totale Türöffnung nach innen und außen. Griff inklusiv. In der Verpackung sind 2 Dichtungen zur Installation mit oder ohne Schwalleiste enthalten.

L	A	B	C	KG	
76 - 78 cm	26,1 - 28,1	49	32,5	41	1
86 - 88 cm	29,3 - 31,3	56	37	45	1
96 - 98 cm	35,5 - 37,5	60	40	49	1
116 - 118 cm	44,3 - 46,3	71	48	68	2

AN	01	14
Larghezza - estensibilità Breadth - extensibility Largeur - extensibilité Composición - extensibilidad Breedte - aanpassingsvermogen Breite - Anpassungsfähigkeit	cod.	cod.
L 76 - 78 cm	B9711 S AN 01	B9711 S AN 14
L 86 - 88 cm	B9712 S AN 01	B9712 S AN 14
L 96 - 98 cm	B9713 S AN 01	B9713 S AN 14
L 116 - 118 cm	B9715 S AN 01	B9715 S AN 14

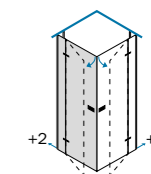

Porta a battente destra / Right pivot door
 Porte battante droite / Puerta batiente derecha
 Rechter draaideur / Rechte Drehtür

H max 217cm
 L min 66cm/max 160cm

Larghezza - estensibilità Breadth - extensibility Largeur - extensibilité Composición - extensibilidad Breedte - aanpassingsvermogen Breite - Anpassungsfähigkeit	cod.	cod.
L 76 - 78 cm	B9711 D AN 01	B9711 D AN 14
L 86 - 88 cm	B9712 D AN 01	B9712 D AN 14
L 96 - 98 cm	B9713 D AN 01	B9713 D AN 14
L 116 - 118 cm	B9715 D AN 01	B9715 D AN 14

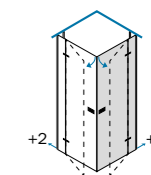

Maniglia / Handle / Poignée / Tiradora / Greep / Griff

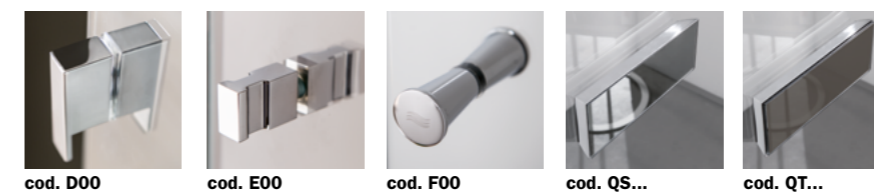

Cerniera / Hinge
 Charnière / Bisagra
 Scharnieren / Scharniere

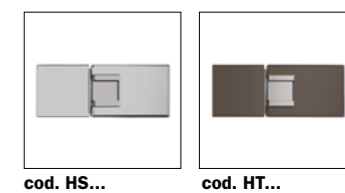

Le dimensioni sono in mm / Sizes in mm /
Les dimensions sont indiquées en mm /
Las medidas son en mm /
De afmetingen zijn vermeld in mm / Maßangaben in mm

