



S9110 SALVORE

S9210 PIRANO

S9311 PARENZO

S9310 PARENZO

S9410 ROVIGNO

S9510 ALBONA

S9610 LUSSINO

S9710 ORSERA

S9810 ISOLA

IP 44  LED  

**INDA S.p.a - Via dell'Industria 41
I - 24040 Pagazzano (BG)**

**Made in Via Cav. Orvile Venturato, 1
37040 BONA VIGO (VR) – ITALY**

**www.inda.net
info@inda.net**

GB Maintenance

Clean the mirror only with a wet cloth..

Do not use any detergents. Clean the edges with a dry cloth to avoid corrosion of the backing. Keep away aggressive cleansers as acetone, alcohol or detergents for W.C.

Warranty

The guarantee must be exercised by a complaint to the manufacturer through the dealer where the product has been purchased. The product is guaranteed for 24 months (2 years) from the date of purchase, as evidenced by a receipt stating the name of the dealer. The warranty only covers operation flaws resulting from manufacturing defects. The eventual failure of the product must be checked and accepted by the manufacturer. The guarantee only commits the manufacturer to repair and /or replace defective components: it is therefore excluded any further claims by the user.

The warranty is void if:

- The installation does not meet the installation instructions provided by the manufacturer.
- The operating defect results from tampering or unauthorized intervention by the manufacturer
- The malfunction is caused by abnormal wear of the components due to negligence in the use and ordinary maintenance

I Manutenzione

Pulire lo specchio con un panno umido. Non usare detersivi.

I bordi dello specchio devono essere puliti solo con un panno asciutto per evitare alterazioni della superficie riflettente.

Non mettere vicino allo specchio prodotti aggressivi quali: acetone, alcool, detersivi per W.C. ecc.

Garanzia

La garanzia deve essere esercitata facendo reclamo, al fabbricante, tramite il rivenditore presso il quale è stata acquistato il prodotto. Il prodotto è garantito per 24 mesi (2 anni) dalla data d'acquisto, comprovata da un documento fiscale che riporti il nominativo del rivenditore.

La garanzia copre esclusivamente vizi di funzionamento conseguenti a difetti di fabbricazione.

L'eventuale non conformità del prodotto deve essere verificata e accettata dal fabbricante.

La garanzia impegna il fabbricante solo alla riparazione e/o sostituzione dei componenti difettosi: è pertanto esclusa qualsiasi ulteriore pretesa da parte dell'utilizzatore.

La garanzia decade automaticamente quando:

- L'installazione non è conforme alle istruzioni di montaggio fornite dal fabbricante.
- Il vizio di funzionamento è conseguente a manomissione o a interventi non autorizzati dal fabbricante.
- Il funzionamento difettoso è causato da una usura anomala dei componenti dovuta a negligenza nell'uso e nell'ordinaria manutenzione.

F Entretien

Nettoyer le miroir avec une peau de chamois humide. Ne pas employer les détergers d'usage courant. Les bords du miroir doivent être nettoyés à sec pour éviter une détérioration des couches réfléchissantes. Ne pas déposer, à proximité du miroir, des produits agressifs tels que: dissolvant pour vernis à ongles, alcool, détergers pour W.C. etc.

Garantie

La garantie est opposable au fabricant à travers le revendeur auprès duquel le produit a été acheté. Le produit est garanti pour une période de 24 mois (2 ans) à partir de la date d'achat justifiée par la facture sur laquelle figure le nom du revendeur.

La garantie couvre exclusivement les vices de fonctionnement consécutifs à des défauts de fabrication. L'éventuelle non-conformité du produit doit être vérifiée et acceptée par le fabricant.

La garantie engage uniquement le fabricant à la réparation et/ou le remplacement des composants défectueux: de ce fait, sont exclues toutes poursuites ultérieures de la part de l'utilisateur.

La garantie devient caduc si:

- L'installation n'est pas conforme aux instructions de montage fournies par le fabricant.
- Le vice de fonctionnement est consécutif à une utilisation non conforme du produit ou à une intervention non autorisée par le fabricant.
- Le fonctionnement défectueux est causé par une usure anormale des composants due à une négligence tant au niveau de l'utilisation que de l'entretien.

D Pflege

Die Spiegelflächen nur mit feuchtem Fensterleder reinigen. Keine handelsüblichen Glasreinigungsmittel verwenden.

Die Spiegelkanten nur trocken abwischen, da sonst Belagfehler entstehen können.

Keine offenen W.C. und Rohreiniger, Alkohol, Nagellackentferner u.ä. in Spiegelnähe aufbewahren.

Garantie

Die Garantie kann ausgeübt werden mit der Beschwerde an den Hersteller über den Händler, bei dem Sie das Produkt erworben haben. Das Produkt hat eine Garantie von 24 Monaten (2 Jahre) ab Kaufdatum, nachgewiesen durch einen Einkaufsbeleg mit den Angaben des Verkäufers.

Die Garantie deckt nur Mängel von Funktionsfehler die durch Produktionsfehler verursacht wurden.

Eventuelle mögliche Mängeln werden geprüft und müssen vom Hersteller akzeptiert werden.

Die Garantie verpflichtet den Hersteller die mangelhafte Ware zu reparieren bzw. zu ersetzen: jede weitere Anforderung des Endkunden ist von daher ausgeschlossen.

Die Garantie entfällt automatisch wenn:

-Die Installation nicht gemäß der Montageanleitung des Herstellers durchgeführt wurde.

-Der Funktionsfehler durch einen unsachgemäßen Einwirken oder von Reparaturen die nicht vom Hersteller genehmigt sind.

-Das fehlerhafte Funktionieren wird verursacht von einen übermäßigen Verschleiß der Komponenten die durch Nachlässigkeit beim Gebrauch oder bei der Pflege entstehen.

NL Onderhoud

De spiegel enkel poetsen met een vochtige doek. Geen reinigingsmiddelen gebruiken.

De spiegelrand enkel met een droge doek reinigen om corrosie van de spiegelplaat te vermijden.

Geen bijtende producten: zoals aceton, alcohol, wc-product enz., in de buurt van de spiegel bewaren.

Garantie

U kunt zich beroepen op de garantie door een klachtmelding te doen bij de fabricant, via het verkooppunt waar u het product heeft aangekocht. Het product heeft een garantie van 24 maanden (2 jaar) vanaf de aankoopdatum, te bewijzen met een geldig aankoopbewijs waarop de naam van het verkooppunt staat vermeld. De garantie dekt enkel gebreken in functionering, veroorzaakt door productiefouten. In geval van eventuele niet conformiteit van het product, moet dit worden onderzocht en aanvaard door de fabrikant.

De garantie verplicht de fabrikant enkel tot de reparatie en/of vervanging van de defecte onderdelen: eventuele bijkomende vorderingen van de gebruiker zijn uitgesloten.

De garantie verloopt automatisch wanneer:

- De installatie niet overeenkomt met de montage instructies verschaft door de fabrikant.

- De gebreken zijn veroorzaakt door manipulatie of niet erkende interventies door de fabrikant.

- Het gebrek wordt veroorzaakt door een abnormale slijtage van de onderdelen als gevolg van nalatigheid in het gebruik en het dagelijks onderhoud.

E Manutención

Limpiar el espejo con un paño húmedo. No use detergentes.

Los bordes del espejo solo deben limpiarse con un paño seco para evitar alteraciones en la superficie reflectante.

No depósite, cerca del espejo, productos agresivos tales como: acetona, alcohol, detergentes para W.C. etc..

Garantía

La garantía debe ser ejercitada haciendo el correspondiente reclamo al fabricante a través del revendedor al cual se compró le producto. La pared de ducha está garantizada por 24 meses (2 años) desde la fecha de compra, comprobada con un documento fiscal que contenga el nombre del revendedor. La garantía cubre exclusivamente vicios de funcionamiento consecuentes a defectos de fabricación. Eventualmente, la no conformidad del producto deberá ser verificada y aceptada por el fabricante.

La garantía responsabiliza al fabricante de la reparación y/o sustitución de componentes defectuosos: queda por lo tanto, excluida cualquier ulterior pretensión por parte del usuario.

La garantía cesa automáticamente cuando:

-La instalación no sea conforme a las instrucciones de montaje suministradas por el fabricante.

-El defecto de funcionamiento sea consecuencia de manipulación o de intervenciones no autorizadas por el fabricante.

-El funcionamiento defectuoso sea causado por un uso anómalo de los componentes debido a negligencia en el uso o en la ordinaria manutención.

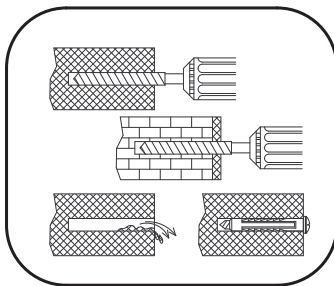
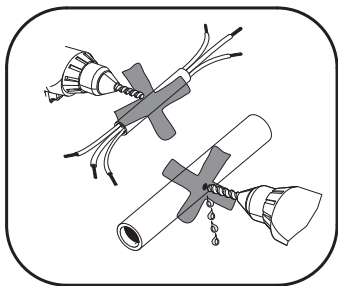

GB

INSTALLATION

Installation should be performed by specialised personnel.

Be sure that the wall where the furniture have to be mounted grants suitable compactness and resistance characteristics.

The best results can be obtained by mounting on concret or brick walls that are, plastered or tiled.

If the wall is not built in concret or bricks, consult a specialist before installation.

Drill with a bit as shown in the pictures and make sure they are free of dust before inserting screw anchors.

Warning! before proceeding to drill the walls, make sure that there are no electrical wires or pipes water/gas.

Screw light.

Angular protections must be removed only during the final mounting step in order to avoid any damage.

I

INSTALLAZIONE

L'installazione deve essere eseguita solo da personale specializzato.

Assicurarsi che la parete su cui si intende fissare i mobili offra le opportune caratteristiche di resistenza e compattezza.

I migliori risultati si ottengono con montaggi su muri in calcestruzzo o mattoni, intonacati ed eventualmente rivestiti con piastrelle.

Se il muro è realizzato in materiale diverso da calcestruzzo o mattoni, consultare uno specialista prima dell'installazione.

Eeguire i fori con la punta indicata nelle figure, avendo cura di liberarli dalla polvere prima di introdurre i tasselli.

Attenzione! prima di procedere alla foratura delle pareti, accertarsi che non siano presenti cavi elettrici o tubi acqua/gas.

Avvitare le viti a fondo.

Le protezioni angolari devono essere tolte solamente nella fase finale del montaggio in modo da evitarne il danneggiamento.

F

INSTALLATION

L'installation de doit être effectuée que par le personnel spécialisé.

S'assurer que le mur où les meubles doivent être fixés, soit compact et résistant.

On obtient les meilleurs résultats sur les murs, crépis et éventuellement carrelés, en béton ou en briques.

Si le mur n'est pas en béton ou en briques, consulter un spécialiste avant d'effectuer l'installation.

Percer les trous avec la pointe comme indiqué sur le dessin en ayant soin d'enlever toute la poussière avant d'y introduire les chevilles.

F **Attention!** avant de procéder au perçage des murs, vérifier qu'ils ne recèlent pas de conduits électriques, d'eau ou de gaz.
Bien visser.
Les protections angulaires doivent être enlevées seulement à la fin de l'installation pour éviter tout dommage.

D **INSTALLATION**
Die Installation darf nur durch spezialisiertes Personal erfolgen.
Vergewissern Sie sich, daß die Wand, auf welcher die Wandhallerungen befestigt werden sollen, die notwendigen Eigenschaften hat.
Die besten Ergebnisse erzielen Sie bei Installation aut verputzten und eventuell verfliesen Beton-oder Ziegelmauern.
Wenn es sich nicht um Beton-oder Ziegelmauern handelt, wenden Sie sich vor der Installation an einen Fachmann.
Benutzen Sie für die Bohrungen einen Bohrer, wie in der Abbildung gezeigt und reinigen Sie sie, bevor Sie die Düel einbringen.
Achtung! Bevor Sie in die Wände bohren, stellen Sie bitte fest, dass keine Stromkabel. Ziehen Sie die Schrauben fest an.
Die Eckenschützer dürfen erst in der letzten Phase der Montage entfernt werden, um Beschädigungen zu vermeiden.

NL **INSTALLATIE**
De installatie mag alleen door bevoegd personeel worden gedaan.
Verzeker u ervan dat de wand waaraan u net meubel wilt monteren stevig genoeg is. Montage aan geplamuurde en eventueel betegelde betonnen of bakstenen wanden levert de beste resultaten.
Voor de montage aan een wand van ander materiaal dan beton of baksteen dient u een vakman te raadplegen.
Boor gaten in de wand met gebruik van het boortje dat is aangegeven in de afbeeldingen en verwijder het gruis uit de gaten voordat u de bijgeleverde pluggen erin plaats.
Dit produkt is gekeurd voor het draagvermogen zaals aangegeven in de afbeelding. **Opgelet!** Voordat er overgegaan kan worden tot het boren in de wanden, moet u ervan verzekerd zijn dat er geen elektrische draden of water/gaspijpen aanwezig zijn.
Draai de schroeven volledig aan.
Hoekbeschermingen mogen pas in de laatste fase van de montage worden verwijderd om schade te voorkomen.

E **INSTALACION**
La instalación debe ser efectuada sólo por personal especializado.
Asegurarse de que la pared donde se va a montar los muebles sea suficientemente resistente y sólida.
Los mejores resultados se obtienen en montajes sobre paredes de hormigón, ladrillos o revestimientos ceramicos.
Si la pared es de otros materiales,consultar con un técnico antes de la instalación.
Hacer los agujeros con la broca indicada en los dibujos teniendo la precaución de limpiar el polvo antes de introducir los tacos.
Atención! Antes de proceder a agujerear las paredes, asegurarse que no hubiesen cables eléctricos o tuberías de agua/gas.
Atomillar a fondo.
Las protecciones de las esquinas deben quitarse solo en la etapa final del montaje para evitar daños.



Installation and electrical connections must be carried out by qualified personnel only. Carefully follow all regulations regarding installation and systems that are applicable in the country where the product is to be installed.

PLEASE NOTE:

- This article must be protected by a differential switch with $I_{\Delta n} \leq 30\text{mA}$
- Before any operation (cleaning – changing light bulbs – installing the luminaire) always disconnect the power supply.
- Before installing, check that the position chosen is compliant with requirements for safety distances under the standards of the country where the product is to be installed.
- The instruction sheet must be kept and made available to personnel entrusted with cleaning/maintenance operations.
- This article is suitable for indoor use only.
- Connect the appliance to an efficient earth wire
- If the wire and/or some other components are damaged, they must be immediately replaced with spare parts.
This should be done only by specialized people, to ensure product safety. INDA disclaims any liability for failure to comply with this obligation.
- The junction box must be built recessed into the wall. It must be made of insulated material and have a lid that closes completely. It also must have a protection level that is at least equal to that of the device.
- This article can be independently connected to the lighting line and the user socket line, in agreement with the regulations in force for electrical systems. Doubling the two systems solves the requirement in hotels of enabling sockets only if explicitly requested by the customer.
- Connect schuko plugs, with a similar degree of protection class of the instrument.
- Classification under EN 62471 'Exempt Group' for photo biological risks
- This article must be used only if complete with protection screen.
- Connect both the lamp and the power supply wires with a terminal strip E (2 poles 1,5mm min TA 25* IP44) and place them in the junction box.



Disposal of Waste Electrical and Electronic Equipment (WEEE) in the European Union.

This symbol appears on the product or on the packaging to indicate that the product must be collected separately. Users must arrange for the disposal of worn out equipment by taking it to the proper collection centre for recycling waste electrical and electronic equipment. Separate collection and recycling of worn out equipment during the disposal process favours the conservation of natural resources and guarantees safe disposal of said equipment protecting both the environment and human health. For more information on the collection centres for worn out equipment, contact the sales outlet where the product was purchased.

CLEANING

Quality, technological processes and materials are the features that determine the high standards of our accessories. However, to avoid surface alterations, it is necessary to follow a few guidelines. Clean all finishes exclusively with soap and water, and dry with a soft cloth. Do not use coarse cloths, abrasive products, acids, ammonia products, caustic substances, bleach or solvents.

In case of contact with these substances, rinse surfaces immediately and wipe dry. Remember that even fumes can damage metal. Wash accessories next to the toilet bowl at regular intervals to avoid corrosion.



L'installazione e il collegamento elettrico devono essere eseguiti solo da personale specializzato. Attenersi scrupolosamente alle prescrizioni impiantistiche e di installazione previste nel paese in cui viene installato il prodotto.

ATTENZIONE

- L'apparecchio deve essere protetto ad un interruttore differenziale con $I_{\Delta n} \leq 30\text{mA}$
- Prima di qualsiasi operazione (pulizia-sostituzione delle lampadine-installazione dell'apparecchio) togliere sempre tensione dall'impianto.
- Prima di effettuare l'installazione verificare che la posizione scelta sia conforme alle distanze di sicurezza previste dalle normative del paese dove viene installato l'apparecchio
- Il foglio istruzioni deve essere conservato e consegnato al personale addetto alla pulizia / manutenzione
- L'apparecchio è adatto solo per uso interno.
- Collegare l'apparecchio ad un cavo di messa a terra efficiente.
- Se il cavo di alimentazione e/o altri componenti sono danneggiati devono essere immediatamente sostituiti con pezzi di ricambio l'operazione deve essere eseguita solo da personale specializzato al fine di garantire la sicurezza del prodotto. INDA declina ogni responsabilità per il mancato rispetto del suddetto obbligo.
- La scatola di derivazione da predisporre nel muro, deve essere di materiale isolante, provvista di coperchio completamente chiuso e avere il grado di protezione almeno pari a quello dell'apparecchio.
- Lo specchio è predisposto per l'allacciamento indipendente alla linea di illuminazione e alla linea presa per utenza, in accordo con le normative vigenti per gli impianti elettrici. Lo sdoppiamento dei due impianti dà soluzione alla necessità che esiste negli alberghi e negli hotels, di abilitare le prese solo su esplicita richiesta del cliente.
- Collegare alla presa presente sull'apparecchio, spine schuko con grado di protezione pari a quello dell'apparecchio
- Classificazione secondo EN 62471 'Gruppo Esente' per i rischi fotobiologici.
- L'apparecchio deve essere usato solo se completo dello schermo di protezione.
- Collegare i cavi della lampada e quelli della rete di alimentazione a una scatola di connessione E (2 Poli min 1,5 mm TA 25° IP44) e introdurla nella scatola di derivazione



Smaltimento di rifiuti di apparecchiature elettriche ed elettroniche (RAEE) nell'Unione Europea.

Questo simbolo che appare sul prodotto o sulla confezione indica che il prodotto è soggetto a raccolta differenziata. Gli utenti devono provvedere allo smaltimento delle apparecchiature da rottamare portandole al luogo di raccolta indicato per il riciclaggio delle apparecchiature elettriche ed elettroniche. La raccolta e il riciclaggio separati delle apparecchiature da rottamare in fase di smaltimento favoriscono la conservazione delle risorse naturali e garantiscono che tali apparecchiature vengano rottamate nel rispetto dell'ambiente e della tutela della salute. Per ulteriori informazioni sui punti di raccolta delle apparecchiature da rottamare, contattare il rivenditore presso il quale è stato acquistato il prodotto.

PULIZIA

Qualità, processi tecnologici e materiali sono le caratteristiche che determinano l'alto livello dei nostri accessori. Comunque al fine di evitare alterazioni delle superfici è necessario seguire alcune avvertenze, pulendo qualsiasi finitura esclusivamente con acqua e sapone, asciugando con un panno morbido. Evitare stracci ruvidi, prodotti abrasivi, sostanze acide, ammoniacali, caustiche, candeggine, solventi e prodotti commerciali multiuso. Nel caso di contatto con tali sostanze occorre sciacquare ed asciugare subito le superfici. Ricordare che anche i vapori possono intaccare il metallo. Lavare periodicamente gli accessori vicino al wc per evitare corrosioni.



L'installation et le raccordement électrique doivent être effectués uniquement par du personnel spécialisé. S'en tenir scrupuleusement aux prescriptions en matière d'équipement et d'installation prévues dans le pays dans lequel le produit est installé.

ATTENTION

- L'appareil doit être protégé par un interrupteur différentiel avec $I_{\Delta n} \leq 30\text{mA}$
- Avant toute opération (nettoyage - remplacement des ampoules - installation de l'appareil), toujours couper la tension de l'installation.
- Avant d'effectuer l'installation, vérifier que la position est bien conforme aux distances de sécurité prévues par les réglementations du pays dans lequel le produit est installé.
- La feuille d'instructions doit être conservée et donnée au personnel chargé du nettoyage/entretien.
- L'appareil convient uniquement pour un usage en intérieur.
- Relier l'appareil à un câble conducteur à terre efficace.
- Si le câble et / ou d'autres pièces sont cassés ils doivent être immédiatement remplacés par des pièces de rechange. Ce ci doit être effectué uniquement par du personnel qualifié pour assurer la sécurité des produits. INDA décline toute responsabilité pour manquement à cette obligation.
- La boîte de dérivation à aménager dans le mur doit être réalisée dans un matériau isolant, équipée d'un couvercle complètement fermé et avoir un degré de protection au moins égal à celui de l'appareil.
- L'appareil est prévu pour le branchement indépendant à la ligne d'éclairage et à la ligne des prises servies conformément aux normes en vigueur applicables aux installations électriques. Cette séparation des deux circuits permet de répondre aux besoins de certains hôtels et autres établissements où les prises sont activées à la seule demande du client.
- Relier à la prise présente sur l'appareil, prise schuko avec degré de protection égale à celui de l'appareil
- Classification selon EN 62471 « Groupe Exempt » pour les risques photo biologiques.
- L'appareil doit être utilisé seulement avec la protection en plein écran.
- Connectez les fils de la lampe et de l'alimentation à une boîte de raccordement E (2 min 1,5 mm Poly TA 25 ° IP44) et mettez dans la boîte de jonction



Élimination des déchets d'équipements électriques et électroniques (DEEE) dans l'Union Européenne.

Ce symbole, présent sur le produit ou l'emballage, indique que le produit doit faire l'objet d'un ramassage sélectif. Les utilisateurs doivent procéder à l'élimination des équipements à mettre au rebut en les acheminant vers le lieu de ramassage indiqué pour le recyclage des équipements électriques et électroniques. Ramasser et recycler de façon séparée les équipements à mettre au rebut lors de la phase d'élimination permet de mieux préserver les ressources naturelles. Cela permet aussi de garantir que ces équipements soient mis au rebut dans le respect de l'environnement et de la protection de la santé. Pour plus d'informations sur les points de collecte des équipements à mettre au rebut, veuillez contacter le revendeur chez qui vous avez acheté le produit.

NETTOYAGE

Nos accessoires se distinguent par le niveau élevé de leur qualité, de leur processus technologiques et de leurs matériaux. Toutefois, afin d'éviter d'abîmer les surfaces, il est nécessaire de suivre certaines recommandations, en nettoyant toutes les finitions uniquement avec de l'eau et du savon, en les essuyant avec un chiffon doux. Éviter d'utiliser des chiffons rugueux, des produits abrasifs, des substances acides, ammoniacales, caustiques, de l'eau de Javel, des solvants et des produits commerciaux multi-usages.

En cas de contact avec ces substances, rincer et essuyer aussitôt les surfaces.

Ne pas oublier que même les vapeurs peuvent corroder le métal.

Laver régulièrement les accessoires à côté de la cuvette WC afin d'éviter toute corrosion.



Installation und Stromanschluss sind ausschließlich von Fachpersonal auszuführen.

Beachten Sie die Bestimmungen für Anlagen und Installationen, die in Ihrem Land vorgeschrieben sind.

ACHTUNG

- Das Gerät muss durch einen Schutzschalter mit Nennfehlerstrom $I_{\Delta n} \leq 30\text{mA}$ geschützt sein.
- Vor jeder Tätigkeit (Reinigung/Ersatz der Lampen/Installation der Leuchte) immer den Strom abschalten.
- Vor der Installation prüfen, dass die gewählte Position mit den im Installationsland vorgeschriebenen Sicherheitsabständen übereinstimmt.
- Die Anweisungen müssen aufbewahrt und dem für Reinigung und Wartung zuständigen Personal übergeben werden.
- Das vorgesehene Befestigungssystem ist nur für festes Mauerwerk geeignet.
- Das Gerät ist ausschließlich zum Gebrauch in Innenräumen vorgesehen.
- Das Gerät mit einem effizienten Kabel-Erdung verbinden.
- Wenn das Netzkabel und / oder andere Bestandteile beschädigt sind, müssen diese sofort durch Ersatzteile ersetzt werden. Dies sollte nur von geschultem Personal durchgeführt werden, um die Produktsicherheit zu gewährleisten. INDA übernimmt keinerlei Haftung für die Nichteinhaltung dieser Verpflichtung.
- Der in der Wand anzubringende Abzweigkasten muss aus Isoliermaterial und mit einem vollständig geschlossenen Deckel versehen sein und einen Schutzgrad aufweisen, der mindestens dem Schutzgrad des Gerätes entspricht.
- Das Gerät hat gemäß den geltenden Vorschriften für elektrische voneinander unabhängige Anschlüsse für Licht und Steckdose Einrichtungen. Durch die separate Ausführung der Anschlüsse besteht die Möglichkeit, wie etwa in Hotels, die Steckdosen nur auf ausdrücklichen Kundenwunsch zu aktivieren
- Schuko-Steckdosen mit dem selben Schutzgrad wie das Gerät mit der vorhandenen Steckdose verwenden
- Einstufung nach EN 62471: ° von photobiologischem Risiko freie Gruppe
- Das Gerät darf ausschließlich und nur mit Schutzblende verwendet werden.
- Schließen Sie die Kabel der Lampe und die der Netzversorgung an einen Stromversorgung an E (2 min 1,5 mm Poly TA 25 ° IP44) und legen sie ganz ganz in die Anschlussdose.



Entsorgung elektrischer und elektronischer Altgeräte (WEEE) in der Europäischen Gemeinschaft.

Dieses auf dem Produkt oder der Verpackung vorhandene Symbol weist darauf hin, dass das Produkt getrennt entsorgt werden muss. Die Benutzer müssen Geräte, die verschrottet werden sollen, zu den angegebenen Sammelstellen zum Recycling elektrischer und elektronischer Altgeräte bringen. Getrennte Sammlung und Recycling von Altgeräten zur Entsorgung fördern die Erhaltung der natürlichen Ressourcen und garantieren, dass diese Geräte gesundheits- und umweltgerecht verschrottet werden. Weitere Information zu den Sammelstellen für Altgeräte erhalten Sie von Ihrem Einzelhändler, bei dem sie das Produkt erworben haben.

REINIGUNG

Unserer Zubehörkomponenten zeichnen sich durch die hohe Qualität der Verfahrenstechniken und Materialien aus. Um Veränderungen der Oberflächen zu vermeiden, sind jedoch einige Hinweise zu beachten. Die Oberflächen dürfen nur mit Wasser und Seife gereinigt und müssen anschließend mit einem weichen Tuch abgetrocknet werden. Raue Lappen, Scheuermittel, säure- und ammoniakhaltige Mittel, Ätzmittel, Chlorbleiche sowie handelsübliche Vielzweck-Lösungsmittel sind zu vermeiden. Sollten die Oberflächen mit diesen Stoffen in Berührung kommen müssen sie sofort abgespült und abgetrocknet werden. Denken Sie daran, dass auch Dämpfe Metall angreifen können. Zur Vermeidung von Korrosion sind Zubehörteile in WC-Nähe regelmäßig abzuspülen.



De installatie en de elektrische verbindingen mogen alleen worden uitgevoerd door gespecialiseerd personeel. Men dient zich strikt te houden aan de voorschriften betreffende installeringen en van installatie die gelden in het land waarin het product wordt geïnstalleerd.

LET OP

- De apparatuur moet worden beschermd door een differentieelschakelaar met $I_{\Delta n} \leq 30\text{mA}$
- Voordat men welke handeling dan ook gaat uitvoeren (schoonmaken-ervangen van lampen, installatie van het apparaat) altijd de stroom van de installatie uitschakelen.
- Voordat men de installatie uitvoert, ervoor zorgen dat de locatie van uw keuze voldoet aan de vereiste veiligheidsafstanden volgens de voorschriften van het land waarin het product wordt geïnstalleerd.
- De handleiding moet worden bewaard en geleverd aan het personeel dat belast is met schoonmaak/onderhoud.
- Het geleverde bevestigingssysteem is alleen geschikt op gebruikt te worden op volle muren of baksteenmuren.
- De apparatuur is alleen geschikt voor gebruik binnenshuis.
- Verbind de apparatuur aan een efficiënt geaarde kabel.
- Indien de voedingskabel en/of andere componenten beschadigd zijn, moeten deze onmiddellijk vervangen worden met andere onderdelen. De vervanging mag alleen uitgevoerd worden door gespecialiseerde technicus om zodoende de veiligheid van het produkt te verzekeren. INDA weigert de verantwoordelijkheid op zich te nemen mits deze verplichting niet uitgevoerd wordt.
- De vertakkingdoos die in de muur moet worden geplaatst, moet van isolerend materiaal zijn, voorzien van een volledig gesloten deksel en een beschermingsgraad die ten minste gelijk is aan die van het apparaat.
- De armatuur is voorbereid voor een onafhankelijke aansluiting op het elektriciteitsnet en op een stopcontact, in overeenstemming met de geldende wetgeving inzake elektrische installaties. Door splitsing van de twee installaties is het mogelijk, bijvoorbeeld in restaurants of hotels, om de stopcontacten alleen te activeren op uitdrukkelijk verzoek van de klant.
- De stopcontact van de apparatuur aansluiten; schuko stopcontact met dezelfde veiligheids graad als die van de apparatuur.
- Classificatie volgens EN 62471 ' Groep vrij van' fotobiologische risico's
- De armatuur mag alleen gebruikt worden samen met het scherm ter bescherming.
- De kabels van de lamp en de kabels van de stroomvoorziening met elkaar verbinden met behulp van een schakeldoos E (polen min. 1,5 mm TA 25° IP44) en invoeren in de aftakkingsdoos



Verwijdering van afval van elektrische en elektronische apparatuur (RAEE) in de Europese Unie.

Dit symbool dat vermeld staat op het product of op de verpakking geeft aan dat het product via een gescheiden afvalverwerkingsstelsel verwijderd moet worden.

De gebruikers moeten er zorg voor dragen dat de te verwijderen apparatuur terecht komt op de plaats die is aangewezen voor recycling van elektrische en elektronische apparatuur. De gescheiden inzameling en hergebruik van apparatuur die wordt weggegooid is gunstig voor het behoud van de natuurlijke grondstoffen en garandeert dat deze apparaten worden verwijderd met respect voor het milieu en de zorg voor de gezondheid. Voor meer informatie over de plaatsen waar apparatuur ingezameld wordt kunt u contact opnemen met de leverancier waar u het product heeft gekocht.

REINIGING

Kwaliteit, technologische processen en materialen zijn de kenmerken die het hoge niveau van onze accessoires bepalen. Het is hoe dan ook noodzakelijk om, teneinde verandering van de oppervlakken te voorkomen, de aanwijzingen op te volgen, en alle afwerkingen uitsluitend met water en zeep schoon te maken en te drogen met een zachte doek. Gebruik geen ruwe doekjes, schuurmiddelen, zure, ammoniakhoudende of bijtende stoffen, bleekmiddelen, oplosmiddelen en multifunctionele reinigingsproducten. Als de oppervlakken hiermee in aanraking komen moet men ze onmiddellijk afspoelen en drogen.

Bedenk dat ook dampen het metaal kunnen aantasten. Reinig de accessoires in de buurt van de wc regelmatig om corrosie te voorkomen.



La instalación y conexión eléctrica deben ser efectuadas solamente por personal especializado. Seguir atentamente las indicaciones y normativas en vigor en el país donde se instala el producto

ATENCIÓN

- El aparato tiene que estar protegido para un interruptor diferencial con $I_{\Delta n} \leq 30\text{mA}$
- Antes de cualquier operación (limpieza, sustitución de bombilla, instalación del aparato) siempre quitar la tensión de la red.
- Antes de efectuar la instalación asegurarse de que la posición elegida sea conforme a las distancias de seguridad previstas por las normativas en vigor en el país donde se instala el producto.
- La hoja de instrucciones tiene que ser conservada y entregada al personal que se encarga de la limpieza y la manutención
- El sistema de fijación suministrado es apto solamente para instalar en pared de ladrillo (no pladur).
- Este aparato es conforme solo para uso interno.
- Ligar o aparelho a um fio de terra eficiente.
- Si el cable de alimentación y/u otros componentes estuviesen dañados, deberán ser reemplazados inmediatamente con repuestos válidos. Esta operación deberá ser realizada únicamente por personal calificado en modo de garantizar la seguridad del producto. INDA se exime de toda responsabilidad en caso de omisión de dicho requisito.
- La caja de derivación que se habrá de predisponer en la pared debe ser de material aislante, con tapa completamente cerrada y con un grado de protección que sea como mínimo del mismo nivel que el del aparato.
- Este aparato es apto para la conexión independiente a la línea de iluminación y a la línea de tomas para usuarios, de acuerdo con la normativa vigente para las instalaciones eléctricas. La separación de las dos instalaciones soluciona la necesidad, que existe en pensiones y hoteles, de habilitar las tomas sólo cuando requerido por el cliente.
- Conectar a la toma incluida en el aparato, un enchufe schuko con el mismo grado de protección
- Clasificación según EN62471: Grupo exente de riesgos foto-biológicos
- El aparato sólo se deberá usar con su pantalla de protección.
- Efectuar a ligação dos fios com a corrente eléctrica entre o terminal E (2 pólos 1,5mm min TA25* IP44) e colocá-los dentro do nicho da parede.



Eliminación de residuos de aparatos eléctricos y electrónicos (RAEE) dentro la Unión Europea

Este símbolo que aparece sobre el producto o la caja indica que el producto es objeto de recogida diferenciada. Los usuarios tengan que asumirse la responsabilidad de eliminar los aparatos que se eliminan llevándolos a un lugar de recogida indicado para la Eliminación de residuos de aparatos eléctricos y electrónicos. La recogida y eliminación separata. En fase de eliminación favorezcan la conservación de los recursos naturales y garantizan que tales aparatos sean eliminados en el respeto del medio ambiente y la tutela de la salud. Para obtener más informaciones referente la recogida de los aparatos para eliminar, contactar el vendedor donde se ha comprado el producto.

LIMPIEZA

Calidad, procesos tecnológicos y materiales son los factores que determinan el elevado nivel de nuestros accesorios. De todas formas, para evitar que se alteren las superficies es preciso seguir algunos consejos: para limpiar cualquier tipo de acabado se usará exclusivamente agua y jabón, secándolo después con un paño suave.

No se habrán de usar trapos ásperos, productos abrasivos, sustancias ácidas, amoniacales, cáusticas, lejía, disolventes ni tampoco productos comerciales multiuso.

En caso de contacto con dichas sustancias habrá que aclarar y secar inmediatamente las superficies.

Recuérdese también que los vapores pueden afectar a los metales.

Límpiese periódicamente los accesorios cercanos al wc para evitar corrosiones.

1

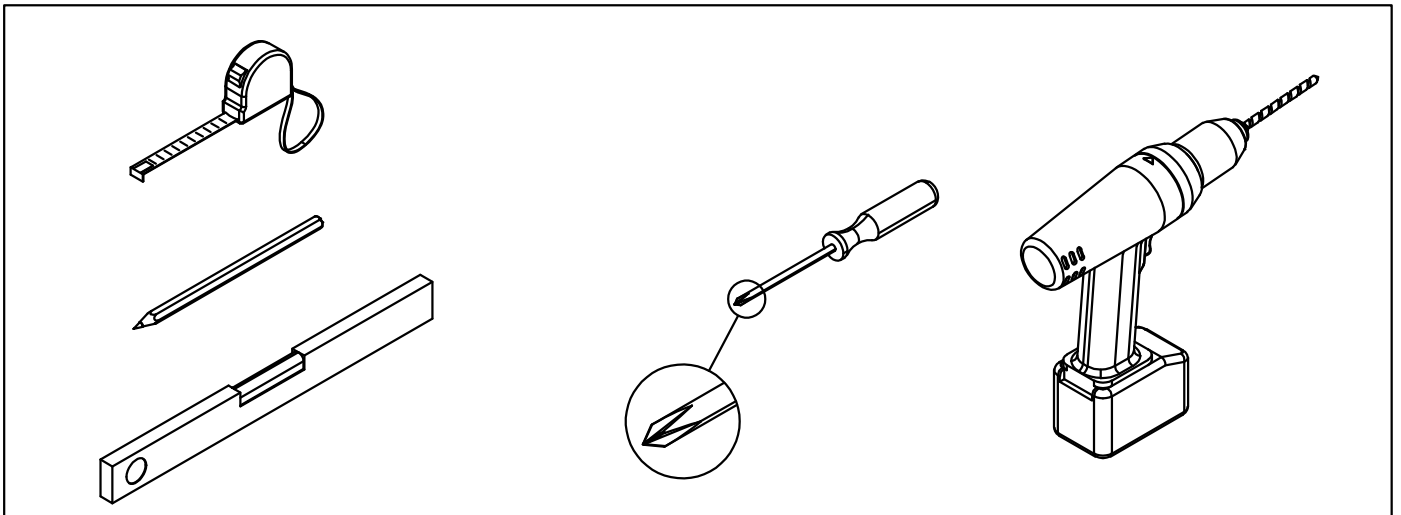
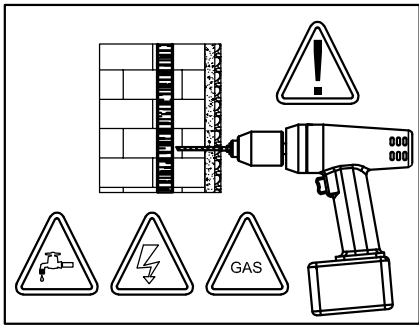
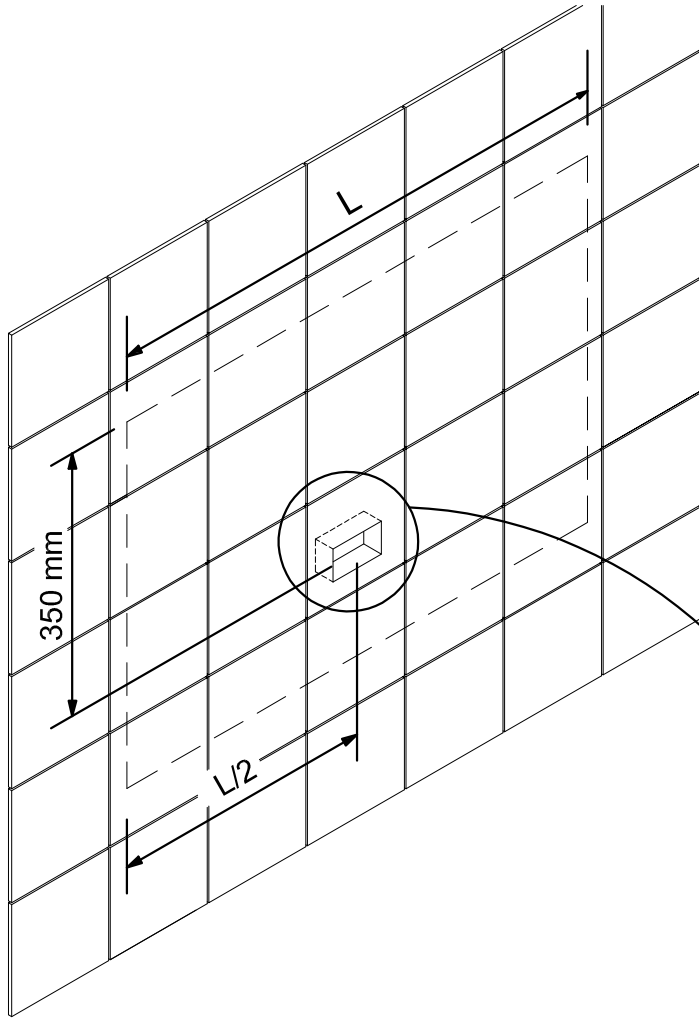

2

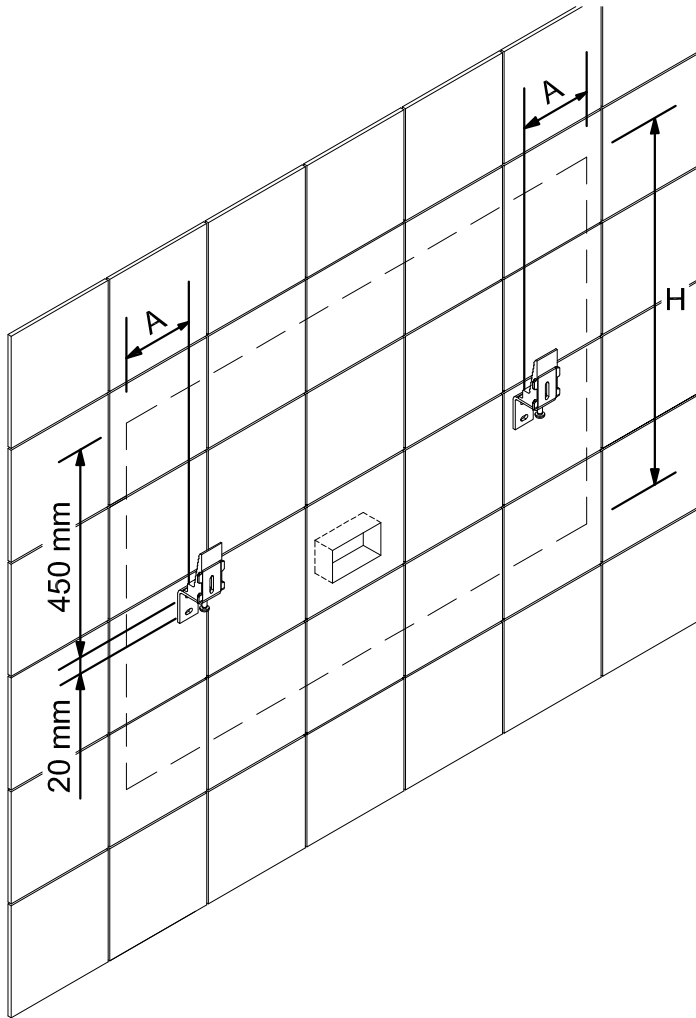

ART.	A	H
S9110	73	800
S9210	67	800
S9311	67	804
S9310	67	804
S9410	67	804
S9510	67	804
S9610	67	804
S9710	67	802
S9810	67	804

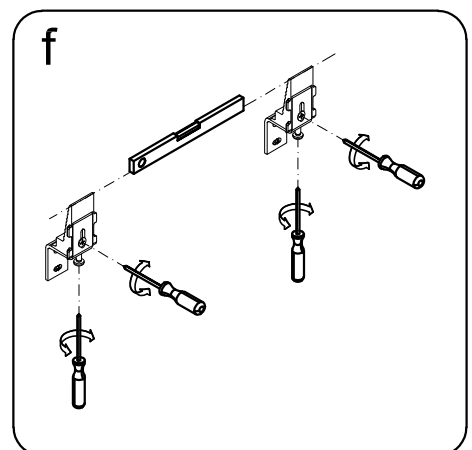
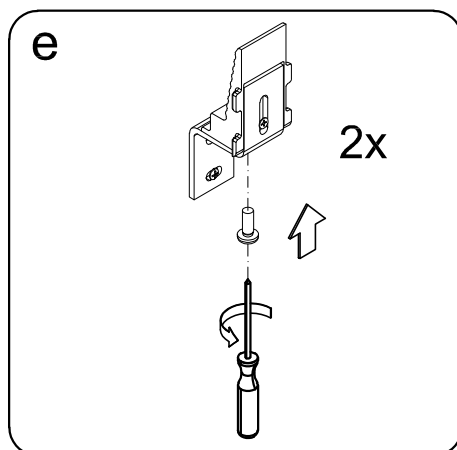
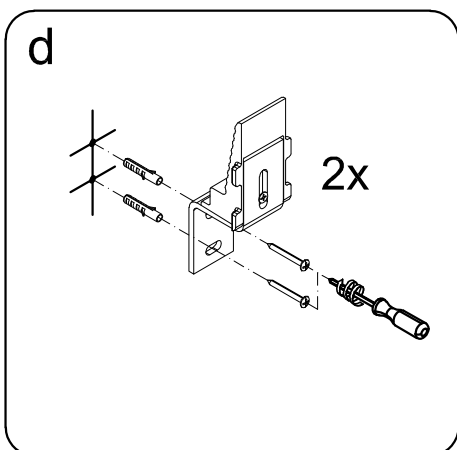
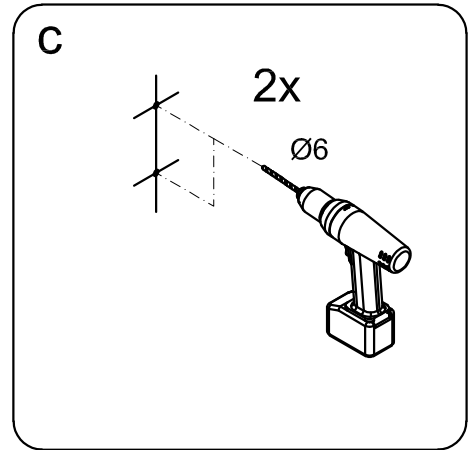
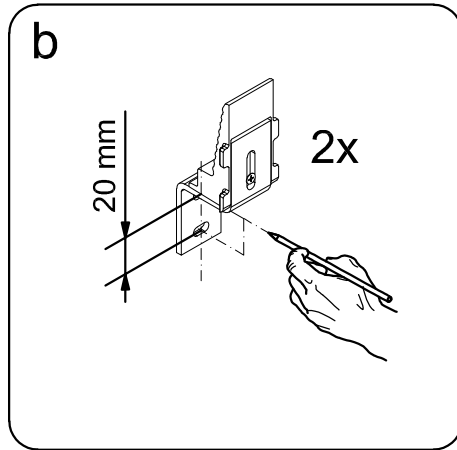
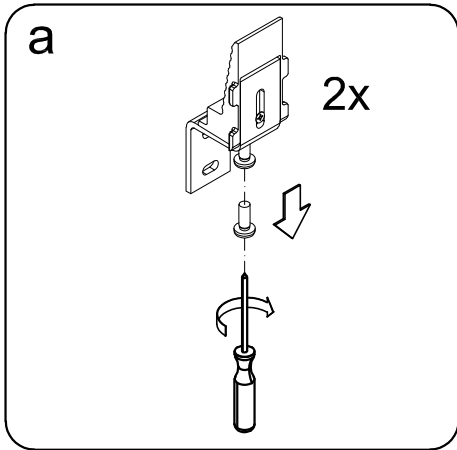

3

S9110

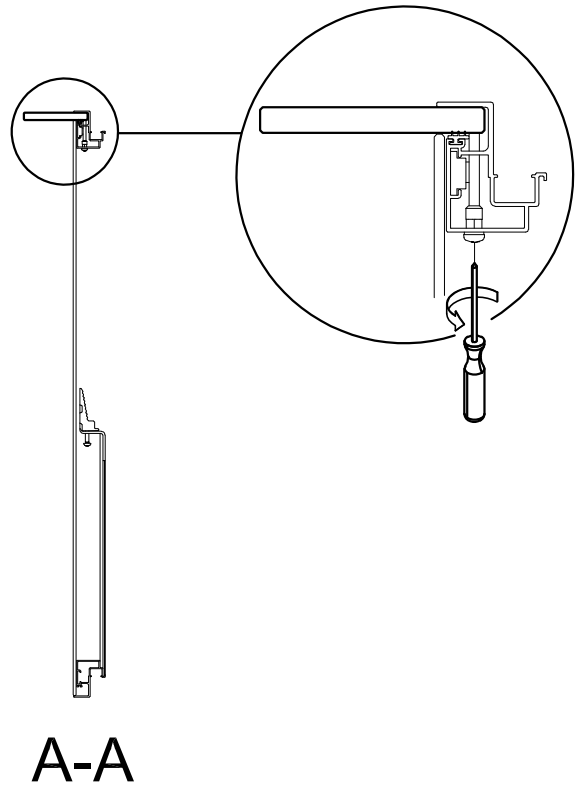
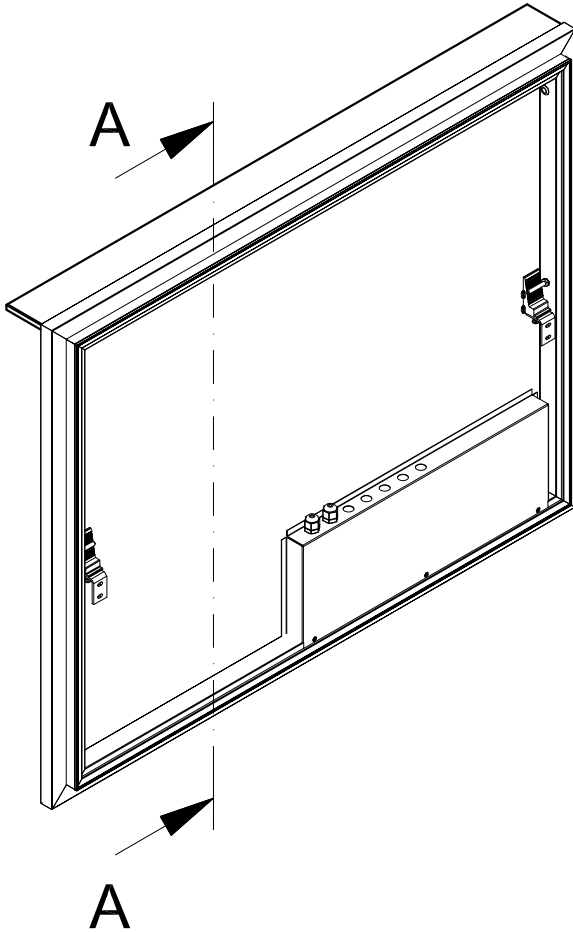
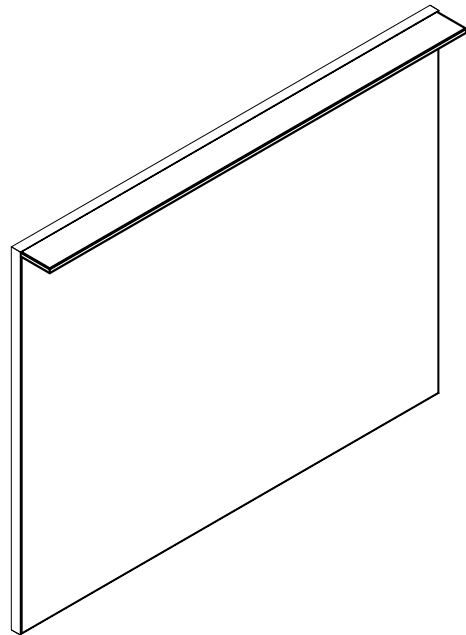
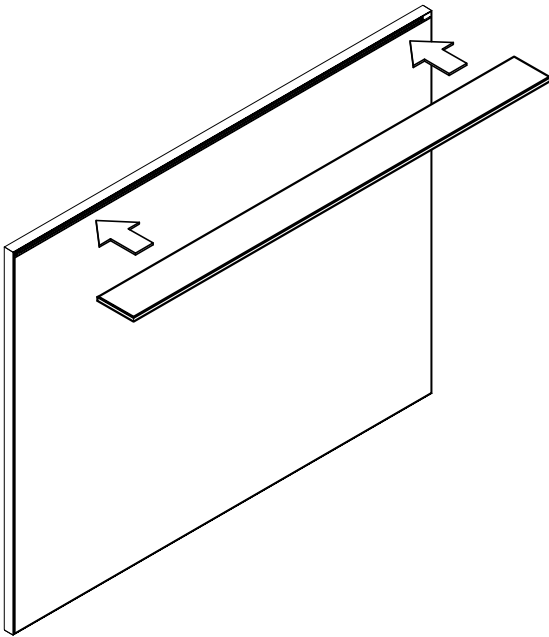

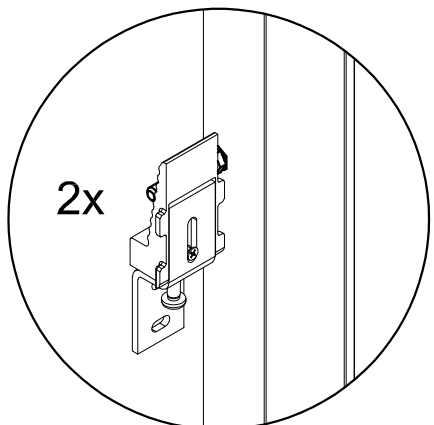
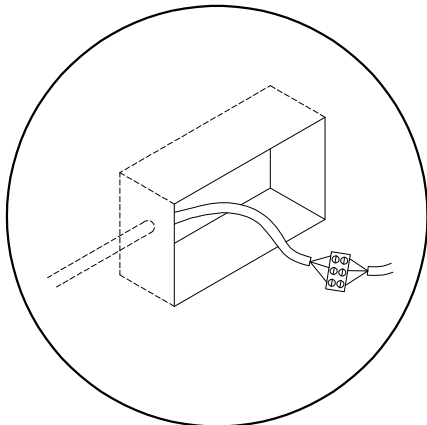
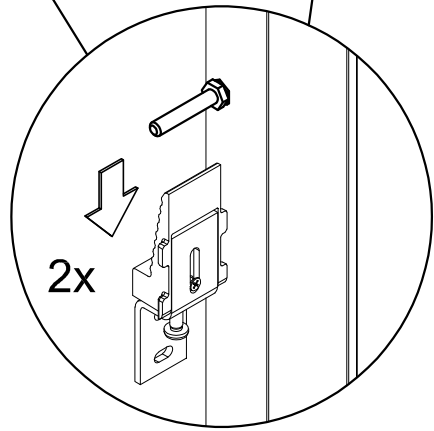
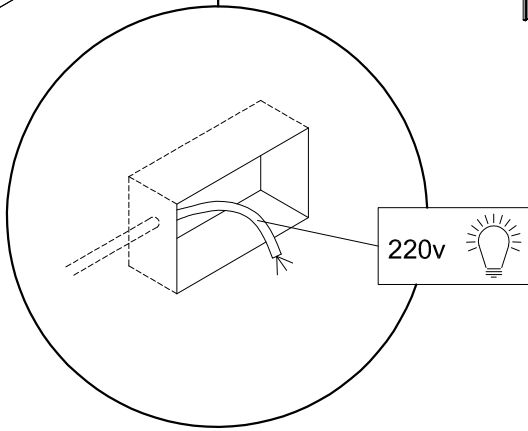
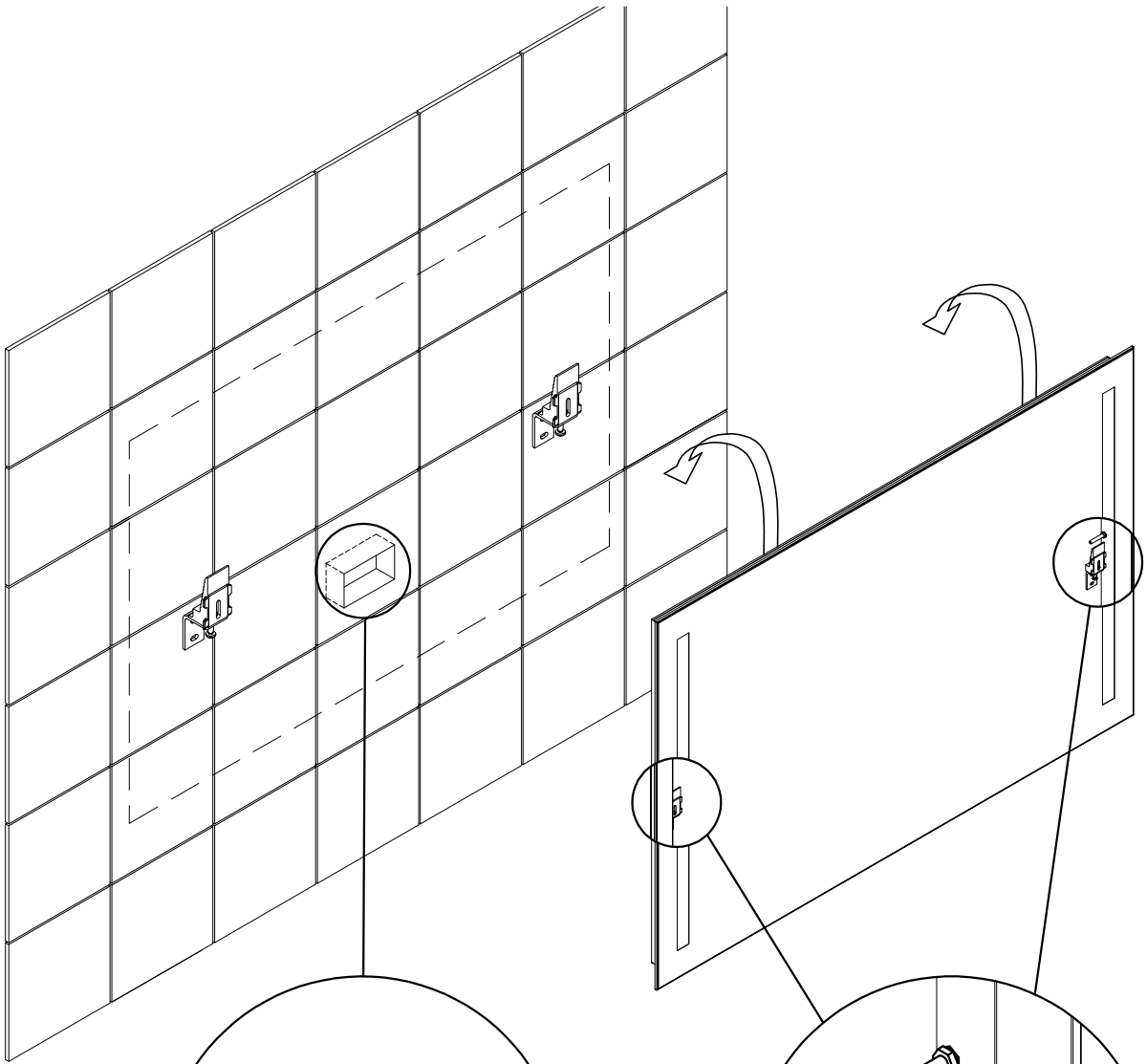

- I Allacciamento elettrico con linea luce sempre alimentata
- D Stromanschluss mit Lichtleitung immer stromversorgt
- E Conexión eléctrica con línea de luz siempre alimentada.
- GB Electric connection with light line always powered.
- FR Connexion électrique avec circuit d'éclairage toujours alimentées.
- NL Elektrische aansluiting met verlichtingscircuit altijd onder stroom.

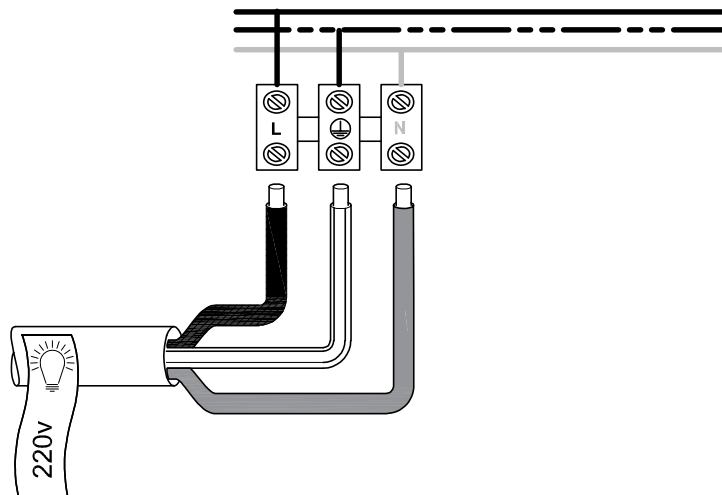

- I Allacciamento elettrico con linea prese sempre alimentata e linea luce interrotta da pulsante esterno
- D Stromanschluss mit Lichtleitung gesteuert durch Raumschalter
- E Conexión eléctrica con línea de luz interrumpida por botón externo
- GB Electric connection with light line interrupted by external button
- FR Connexion électrique avec circuit d'éclairage interrompue par interrupteur externe.
- NL Elektrische aansluiting met verlichtingscircuit onderbroken door externe schakelaar.

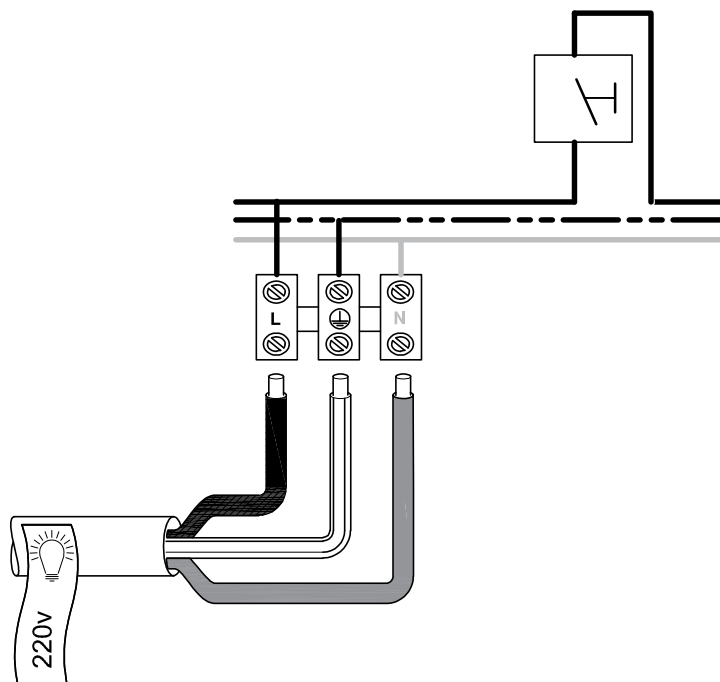

S9510

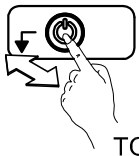

TOUCH TIME < 1s

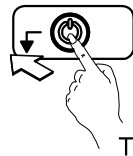
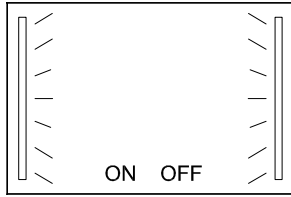

TOUCH TIME > 1s



S9610

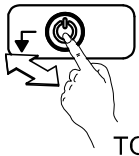

TOUCH TIME < 1s

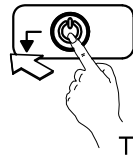
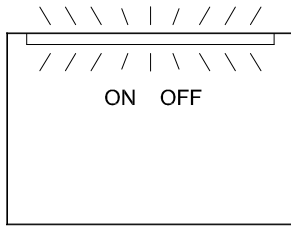

TOUCH TIME > 1s

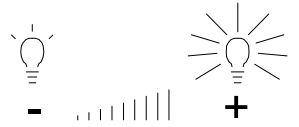

S9110

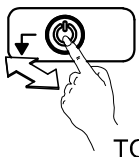

TOUCH TIME < 1s

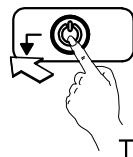
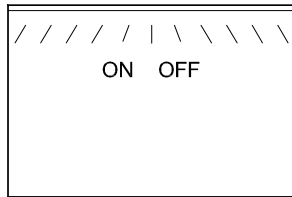

TOUCH TIME > 1s

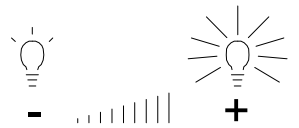

S9410

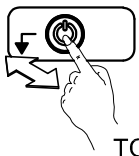

TOUCH TIME < 1s

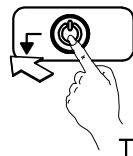
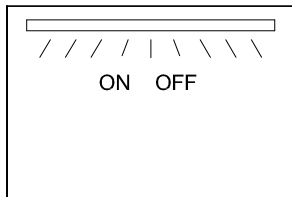

TOUCH TIME > 1s

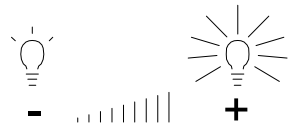

S9710

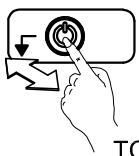

TOUCH TIME < 1s

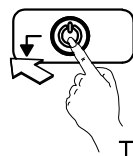
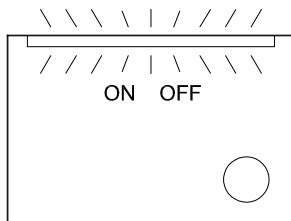

TOUCH TIME > 1s

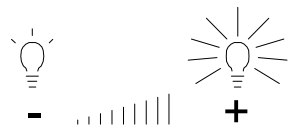

S9210

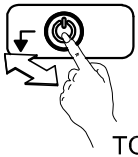

TOUCH TIME < 1s

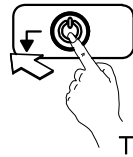
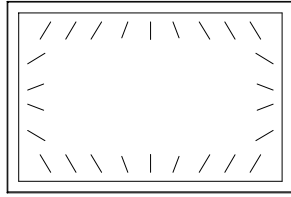

TOUCH TIME > 1s

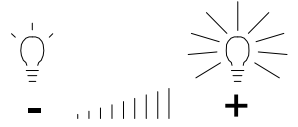

S9810

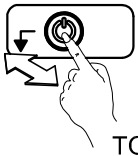

TOUCH TIME < 1s

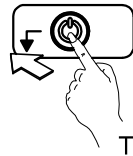
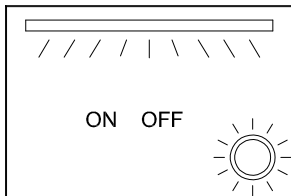

TOUCH TIME > 1s

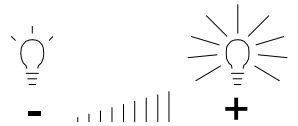

S9311

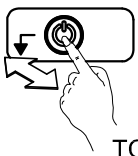

TOUCH TIME < 1s

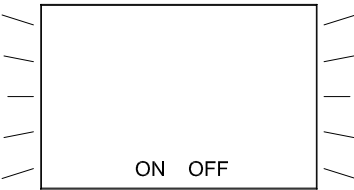

TOUCH TIME > 1s

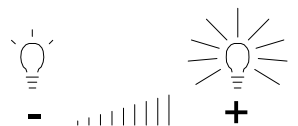

S9310

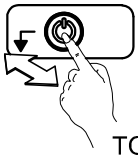

TOUCH TIME < 1s

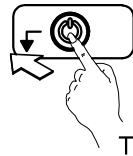
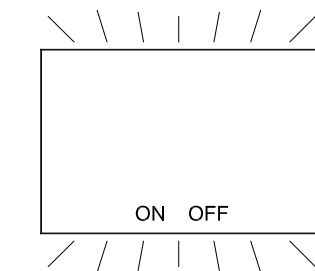

TOUCH TIME > 1s

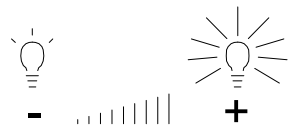

S9210

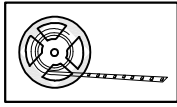
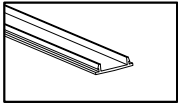
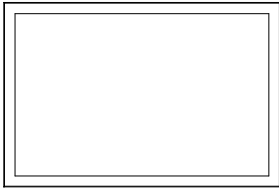

S921010	RMOB00000041	S921010	RMOB00000113
S921015	RMOB00000042	S921015	RMOB00000114
S921020	RMOB00000043	S921020	RMOB00000115
S921025	RMOB00000044	S921025	RMOB00000116
S921030	RMOB00000045	S921030	RMOB00000117
S921035	RMOB00000046	S921035	RMOB00000118
S921040	RMOB00000047	S921040	RMOB00000119
S921045	RMOB00000048	S921045	RMOB00000120
S921050	RMOB00000049	S921050	RMOB00000121
S921060	RMOB00000050	S921060	RMOB00000122
S921070	RMOB00000051	S921070	RMOB00000123
S921080	RMOB00000052	S921080	RMOB00000124

S9310

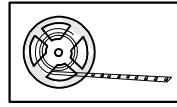
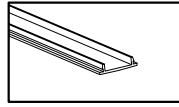

S931010	RMOB00000053	S931010	RMOB00000137
S931015	RMOB00000054	S931015	RMOB00000138
S931020	RMOB00000055	S931020	RMOB00000139
S931025	RMOB00000056	S931025	RMOB00000140
S931030	RMOB00000057	S931030	RMOB00000141
S931035	RMOB00000058	S931035	RMOB00000142
S931040	RMOB00000059	S931040	RMOB00000143
S931045	RMOB00000060	S931045	RMOB00000144
S931050	RMOB00000061	S931050	RMOB00000145
S931060	RMOB00000062	S931060	RMOB00000146
S931070	RMOB00000063	S931070	RMOB00000147
S931080	RMOB00000064	S931080	RMOB00000148

S9311

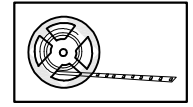
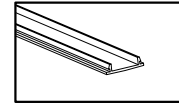

S9311	RMOB00000065	S9311	RMOB00000149
-------	--------------	-------	--------------

S9710

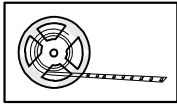
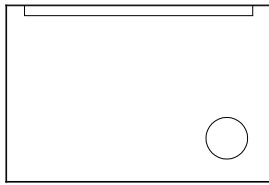

S971010	RMOB00000197
S971015	RMOB00000198
S971020	RMOB00000199
S971025	RMOB00000200
S971030	RMOB00000201
S971035	RMOB00000202
S971040	RMOB00000203
S971045	RMOB00000204
S971050	RMOB00000205
S971060	RMOB00000206
S971070	RMOB00000207
S971080	RMOB00000208

S9610

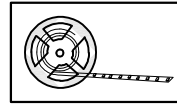
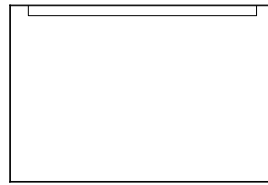

S961010	RMOB00000197
S961015	RMOB00000198
S961020	RMOB00000199
S961025	RMOB00000200
S961030	RMOB00000201
S961035	RMOB00000202
S961040	RMOB00000203
S961045	RMOB00000204
S961050	RMOB00000205
S961060	RMOB00000206
S961070	RMOB00000207
S961080	RMOB00000208

S9510

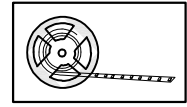
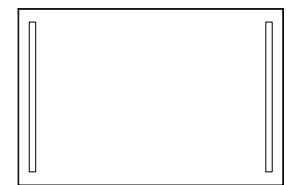

S9510	RMOB00000221
-------	--------------

S9810

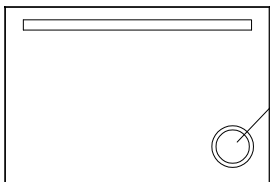

RMOB00000258

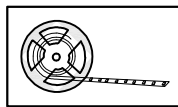

S981010	RMOB00000234
S981015	RMOB00000235
S981020	RMOB00000236
S981025	RMOB00000237
S981030	RMOB00000238
S981035	RMOB00000239
S981040	RMOB00000240
S981045	RMOB00000241
S981050	RMOB00000242
S981060	RMOB00000243
S981070	RMOB00000244
S981080	RMOB00000245

S9410

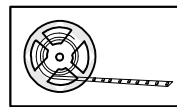

S941010	RMOB00000234
S941015	RMOB00000235
S941020	RMOB00000236
S941025	RMOB00000237
S941030	RMOB00000238
S941035	RMOB00000239
S941040	RMOB00000240
S941045	RMOB00000241
S941050	RMOB00000242
S941060	RMOB00000243
S941070	RMOB00000244
S941080	RMOB00000245

S9110

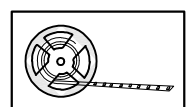
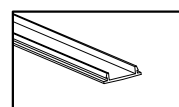
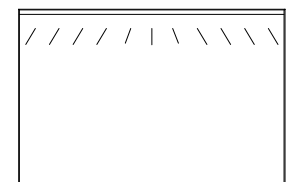

S911010	RMOB00000089	S911010	RMOB00000173
S911015	RMOB00000090	S911015	RMOB00000174
S911020	RMOB00000091	S911020	RMOB00000175
S911025	RMOB00000092	S911025	RMOB00000176
S911030	RMOB00000093	S911030	RMOB00000177
S911035	RMOB00000094	S911035	RMOB00000178
S911040	RMOB00000095	S911040	RMOB00000179
S911045	RMOB00000096	S911045	RMOB00000180
S911050	RMOB00000097	S911050	RMOB00000181
S911060	RMOB00000098	S911060	RMOB00000182
S911070	RMOB00000099	S911070	RMOB00000183
S911080	RMOB00000100	S911080	RMOB00000184

S94-95-96-97-98-9310
RMOB00000260

2x



2x

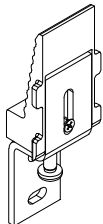

S91-92-9311
RMOB00000261

2x



2x

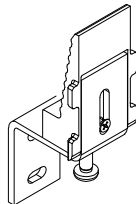

RMOB00000033 50W 12V
RMOB000000274 15W 24V
RMOB000000034 30W 24V
RMOB000000035 60W 24V
RMOB000000036 100W 24V
RMOB000000275 150W 24V

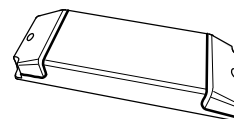

S9610 / S9710
RMOB00000286

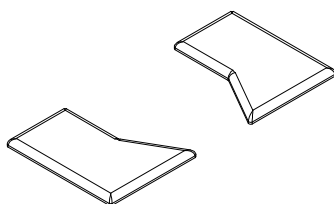

S9110

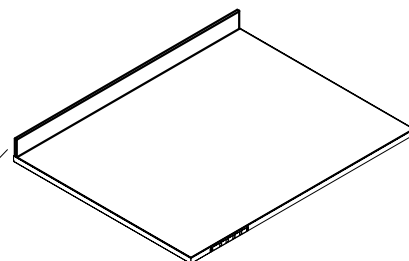

S911010 RMOB00000262
S911015 RMOB00000263
S911020 RMOB00000264
S911025 RMOB00000265
S911030 RMOB00000266
S911035 RMOB00000267
S911040 RMOB00000268
S911045 RMOB00000269
S911050 RMOB00000270
S911060 RMOB00000271
S911070 RMOB00000272
S911080 RMOB00000273

S9110 S9210
RMOB00000276

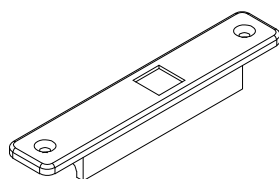

S93-94-95-96-97-9810-9311
RMOB00000277

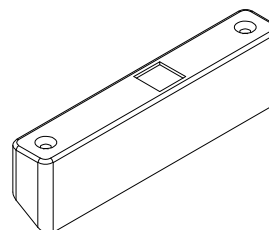

- GB** 24-MONTH WARRANTY: general conditions. ATTENTION: please keep a fiscal purchase document(receipt,bill, invoice etc.) together with this manual
- I** GARANZIA DI 24 MESI: condizioni generali. ATTENZIONE: conservare con questo fascicolo un documento fiscale d'acquisto (scontrino fiscale,bolla d'accompagnamento, fattura ecc.)
- F** GARANTIE DE 24 MOIS: conditions générales. ATTENTION: conserver avec ce dossier un document officiel d'achat (remise fiscale,bordereau de livraison,facture etc.)
- D** GARANTIE VON 24 MONATEN: Allgem.Konditionen. ACHTUNG: Mit diesem Heft bitte auch eine Quittung aufbewahren (Kassenzettel,Lieferschein,Rechnung etc.)
- NL** GARANTIE VAN 24 MAANDEN: algemene voorwaarden OPGELET: bewaar bij dit boekje een fiscaal document van aankoop (kassabon,faktuur etc.)
- E** GARANTÍA DE 24 MESES: condiciones generales ADVERTENCIA: Junto con este folleto, consérvese el justificante de compra (recibo,albarán,factura,etc.).

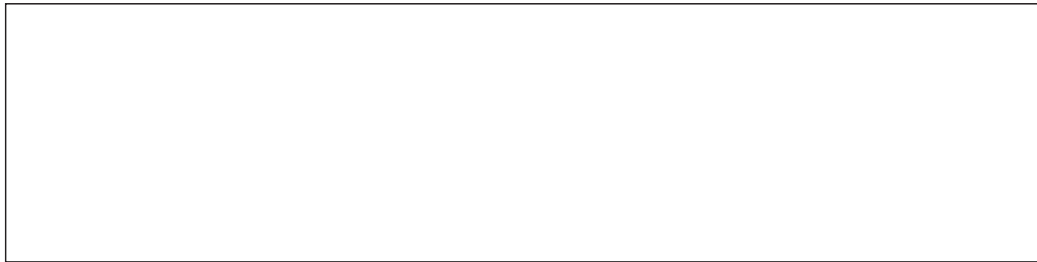



S9114	SALVORE+
S9212	PIRANO+
S9312	PARENZO+
S9412	ROVIGNO+
S9512	ALBONA+
S9612	LUSSINO+
S9712	ORSERA+
S9813	ISOLA+

IP 44  LED  

**INDA S.p.a - Via dell'Industria 41
I - 24040 Pagazzano (BG)**

**Made in Via Cav. Orvile Venturato, 1
37040 BONAVIDO (VR) – ITALY**

**www.inda.net
info@inda.net**

GB Maintenance

Clean the mirror only with a wet cloth..

Do not use any detergents. Clean the edges with a dry cloth to avoid corrosion of the backing. Keep away aggressive cleansers as acetone, alcohol or detergents for W.C.

Warranty

The guarantee must be exercised by a complaint to the manufacturer through the dealer where the product has been purchased. The product is guaranteed for 24 months (2 years) from the date of purchase, as evidenced by a receipt stating the name of the dealer. The warranty only covers operation flaws resulting from manufacturing defects. The eventual failure of the product must be checked and accepted by the manufacturer. The guarantee only commits the manufacturer to repair and /or replace defective components: it is therefore excluded any further claims by the user.

The warranty is void if:

- The installation does not meet the installation instructions provided by the manufacturer.
- The operating defect results from tampering or unauthorized intervention by the manufacturer
- The malfunction is caused by abnormal wear of the components due to negligence in the use and ordinary maintenance

I Manutenzione

Pulire lo specchio con un panno umido. Non usare detersivi.

I bordi dello specchio devono essere puliti solo con un panno asciutto per evitare alterazioni della superficie riflettente.

Non mettere vicino allo specchio prodotti aggressivi quali: acetone, alcool, detersivi per W.C. ecc.

Garanzia

La garanzia deve essere esercitata facendo reclamo, al fabbricante, tramite il rivenditore presso il quale è stata acquistato il prodotto. Il prodotto è garantito per 24 mesi (2 anni) dalla data d'acquisto, comprovata da un documento fiscale che riporti il nominativo del rivenditore.

La garanzia copre esclusivamente vizi di funzionamento conseguenti a difetti di fabbricazione.

L'eventuale non conformità del prodotto deve essere verificata e accettata dal fabbricante.

La garanzia impegna il fabbricante solo alla riparazione e/o sostituzione dei componenti difettosi: è pertanto esclusa qualsiasi ulteriore pretesa da parte dell'utilizzatore.

La garanzia decade automaticamente quando:

- L'installazione non è conforme alle istruzioni di montaggio fornite dal fabbricante.
- Il vizio di funzionamento è conseguente a manomissione o a interventi non autorizzati dal fabbricante.
- Il funzionamento difettoso è causato da una usura anomala dei componenti dovuta a negligenza nell'uso e nell'ordinaria manutenzione.

F Entretien

Nettoyer le miroir avec une peau de chamois humide. Ne pas employer les détergers d'usage courant. Les bords du miroir doivent être nettoyés à sec pour éviter une détérioration des couches réfléchissantes. Ne pas déposer, à proximité du miroir, des produits agressifs tels que: dissolvant pour vernis à ongles, alcool, détergers pour W.C. etc.

Garantie

La garantie est opposable au fabricant à travers le revendeur auprès duquel le produit a été acheté. Le produit est garanti pour une période de 24 mois (2 ans) à partir de la date d'achat justifiée par la facture sur laquelle figure le nom du revendeur.

La garantie couvre exclusivement les vices de fonctionnement consécutifs à des défauts de fabrication. L'éventuelle non-conformité du produit doit être vérifiée et acceptée par le fabricant.

La garantie engage uniquement le fabricant à la réparation et/ou le remplacement des composants défectueux: de ce fait, sont exclues toutes poursuites ultérieures de la part de l'utilisateur.

La garantie devient caduc si:

- L'installation n'est pas conforme aux instructions de montage fournies par le fabricant.
- Le vice de fonctionnement est consécutif à une utilisation non conforme du produit ou à une intervention non autorisée par le fabricant.
- Le fonctionnement défectueux est causé par une usure anormale des composants due à une négligence tant au niveau de l'utilisation que de l'entretien.

D Pflege

Die Spiegelflächen nur mit feuchtem Fensterleder reinigen. Keine handelsüblichen Glasreinigungsmittel verwenden.

Die Spiegelkanten nur trocken abwischen, da sonst Belagfehler entstehen können.

Keine offenen W.C. und Rohrrreiniger, Alkohol, Nagellackentferner u.ä. in Spiegelnähe aufbewahren.

Garantie

Die Garantie kann ausgeübt werden mit der Beschwerde an den Hersteller über den Händler, bei dem Sie das Produkt erworben haben. Das Produkt hat eine Garantie von 24 Monaten (2 Jahre) ab Kaufdatum, nachgewiesen durch einen Einkaufsbeleg mit den Angaben des Verkäufers.

Die Garantie deckt nur Mängel von Funktionsfehler die durch Produktionsfehler verursacht wurden.

Eventuelle mögliche Mängeln werden geprüft und müssen vom Hersteller akzeptiert werden.

Die Garantie verpflichtet den Hersteller die mangelhafte Ware zu reparieren bzw. zu ersetzen: jede weitere Anforderung des Endkunden ist von daher ausgeschlossen.

Die Garantie entfällt automatisch wenn:

-Die Installation nicht gemäß der Montageanleitung des Herstellers durchgeführt wurde.

-Der Funktionsfehler durch einen unsachgemäßen Einwirken oder von Reparaturen die nicht vom Hersteller genehmigt sind.

-Das fehlerhafte Funktionieren wird verursacht von einen übermäßigen Verschleiß der Komponenten die durch Nachlässigkeit beim Gebrauch oder bei der Pflege entstehen.

NL Onderhoud

De spiegel enkel poetsen met een vochtige doek. Geen reinigingsmiddelen gebruiken.

De spiegelrand enkel met een droge doek reinigen om corrosie van de spiegelplaat te vermijden.

Geen bijtende producten: zoals aceton, alcohol, wc-product enz., in de buurt van de spiegel bewaren.

Garantie

U kunt zich beroepen op de garantie door een klachtmelding te doen bij de fabricant, via het verkooppunt waar u het product heeft aangekocht. Het product heeft een garantie van 24 maanden (2 jaar) vanaf de aankoopdatum, te bewijzen met een geldig aankoopbewijs waarop de naam van het verkooppunt staat vermeld. De garantie dekt enkel gebreken in functionering, veroorzaakt door productiefouten. In geval van eventuele niet conformiteit van het product, moet dit worden onderzocht en aanvaard door de fabrikant.

De garantie verplicht de fabrikant enkel tot de reparatie en/of vervanging van de defecte onderdelen: eventuele bijkomende vorderingen van de gebruiker zijn uitgesloten.

De garantie verloopt automatisch wanneer:

- De installatie niet overeenkomt met de montage instructies verschaft door de fabrikant.

- De gebreken zijn veroorzaakt door manipulatie of niet erkende interventies door de fabrikant.

- Het gebrek wordt veroorzaakt door een abnormale slijtage van de onderdelen als gevolg van nalatigheid in het gebruik en het dagelijks onderhoud.

E Manutención

Limpiar el espejo con un paño húmedo. No use detergentes.

Los bordes del espejo solo deben limpiarse con un paño seco para evitar alteraciones en la superficie reflectante.

No depósite, cerca del espejo, productos agresivos tales como: acetona, alcohol, detergentes para W.C. etc..

Garantía

La garantía debe ser ejercitada haciendo el correspondiente reclamo al fabricante a través del revendedor al cual se compró le producto. La pared de ducha está garantizada por 24 meses (2 años) desde la fecha de compra, comprobada con un documento fiscal que contenga el nombre del revendedor. La garantía cubre exclusivamente vicios de funcionamiento consecuentes a defectos de fabricación. Eventualmente, la no conformidad del producto deberá ser verificada y aceptada por el fabricante.

La garantía responsabiliza al fabricante de la reparación y/o sustitución de componentes defectuosos: queda por lo tanto, excluida cualquier ulterior pretensión por parte del usuario.

La garantía cesa automáticamente cuando:

-La instalación no sea conforme a las instrucciones de montaje suministradas por el fabricante.

-El defecto de funcionamiento sea consecuencia de manipulación o de intervenciones no autorizadas por el fabricante.

-El funcionamiento defectuoso sea causado por un uso anómalo de los componentes debido a negligencia en el uso o en la ordinaria manutención.

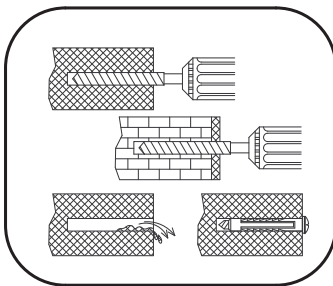
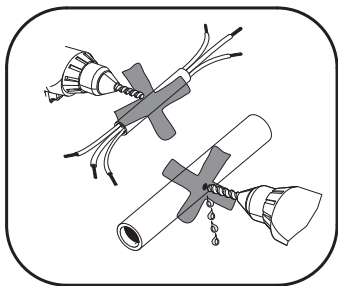

GB

INSTALLATION

Installation should be performed by specialised personnel.

Be sure that the wall where the furniture have to be mounted grants suitable compactness and resistance characteristics.

The best results can be obtained by mounting on concret or brick walls that are, plastered or tiled.

If the wall is not built in concret or bricks, consult a specialist before installation.

Drill with a bit as shown in the pictures and make sure they are free of dust before inserting screw anchors.

Warning! before proceeding to drill the walls, make sure that there are no electrical wires or pipes water/gas.

Screw light.

Angular protections must be removed only during the final mounting step in order to avoid any damage.

I

INSTALLAZIONE

L'installazione deve essere eseguita solo da personale specializzato.

Assicurarsi che la parete su cui si intende fissare i mobili offra le opportune caratteristiche di resistenza e compattezza.

I migliori risultati si ottengono con montaggi su muri in calcestruzzo o mattoni, intonacati ed eventualmente rivestiti con piastrelle.

Se il muro è realizzato in materiale diverso da calcestruzzo o mattoni, consultare uno specialista prima dell'installazione.

Eeguire i fori con la punta indicata nelle figure, avendo cura di liberarli dalla polvere prima di introdurre i tasselli.

Attenzione! prima di procedere alla foratura delle pareti, accertarsi che non siano presenti cavi elettrici o tubi acqua/gas.

Avvitare le viti a fondo.

Le protezioni angolari devono essere tolte solamente nella fase finale del montaggio in modo da evitarne il danneggiamento.

F

INSTALLATION

L'installation de doit être effectuée que par le personnel spécialisé.

S'assurer que le mur où les meubles doivent être fixés, soit compact et résistant.

On obtient les meilleurs résultats sur les murs, crépis et éventuellement carrelés, en béton ou en briques.

Si le mur n'est pas en béton ou en briques, consulter un spécialiste avant d'effectuer l'installation.

Percer les trous avec la pointe comme indiqué sur le dessin en ayant soin d'enlever toute la poussière avant d'y introduire les chevilles.

F **Attention!** avant de procéder au perçage des murs, vérifier qu'ils ne recèlent pas de conduits électriques, d'eau ou de gaz.
Bien visser.
Les protections angulaires doivent être enlevées seulement à la fin de l'installation pour éviter tout dommage.

D **INSTALLATION**
Die Installation darf nur durch spezialisiertes Personal erfolgen.
Vergewissern Sie sich, daß die Wand, auf welcher die Wandhallerungen befestigt werden sollen, die notwendigen Eigenschaften hat.
Die besten Ergebnisse erzielen Sie bei Installation aut verputzten und eventuell verfliesen Beton-oder Ziegelmauern.
Wenn es sich nicht um Beton-oder Ziegelmauern handelt, wenden Sie sich vor der Installation an einen Fachmann.
Benutzen Sie für die Bohrungen einen Bohrer, wie in der Abbildung gezeigt und reinigen Sie sie, bevor Sie die Düel einbringen.
Achtung! Bevor Sie in die Wände bohren, stellen Sie bitte fest, dass keine Stromkabel. Ziehen Sie die Schrauben fest an.
Die Eckenschützer dürfen erst in der letzten Phase der Montage entfernt werden, um Beschädigungen zu vermeiden.

NL **INSTALLATIE**
De installatie mag alleen door bevoegd personeel worden gedaan.
Verzeker u ervan dat de wand waaraan u net meubel wilt monteren stevig genoeg is. Montage aan geplamuurde en eventueel betegelde betonnen of bakstenen wanden levert de beste resultaten.
Voor de montage aan een wand van ander materiaal dan beton of baksteen dient u een vakman te raadplegen.
Boor gaten in de wand met gebruik van het boortje dat is aangegeven in de afbeeldingen en verwijder het gruis uit de gaten voordat u de bijgeleverde pluggen erin plaats.
Dit produkt is gekeurd voor het draagvermogen zaals aangegeven in de afbeelding. **Opgelet!** Voordat er overgegaan kan worden tot het boren in de wanden, moet u ervan verzekerd zijn dat er geen elektrische draden of water/gaspijpen aanwezig zijn.
Draai de schroeven volledig aan.
Hoekbeschermingen mogen pas in de laatste fase van de montage worden verwijderd om schade te voorkomen.

E **INSTALACION**
La instalación debe ser efectuada sólo por personal especializado.
Asegurarse de que la pared donde se va a montar los muebles sea suficientemente resistente y sólida.
Los mejores resultados se obtienen en montajes sobre paredes de hormigón, ladrillos o revestimientos ceramicos.
Si la pared es de otros materiales,consultar con un técnico antes de la instalación.
Hacer los agujeros con la broca indicada en los dibujos teniendo la precaución de limpiar el polvo antes de introducir los tacos.
Atención! Antes de proceder a agujerear las paredes, asegurarse que no hubiesen cables eléctricos o tuberías de agua/gas.
Atomillar a fondo.
Las protecciones de las esquinas deben quitarse solo en la etapa final del montaje para evitar daños.



Installation and electrical connections must be carried out by qualified personnel only. Carefully follow all regulations regarding installation and systems that are applicable in the country where the product is to be installed.

PLEASE NOTE:

- This article must be protected by a differential switch with $I_{\Delta n} \leq 30\text{mA}$
- Before any operation (cleaning – changing light bulbs – installing the luminaire) always disconnect the power supply.
- Before installing, check that the position chosen is compliant with requirements for safety distances under the standards of the country where the product is to be installed.
- The instruction sheet must be kept and made available to personnel entrusted with cleaning/maintenance operations.
- This article is suitable for indoor use only.
- Connect the appliance to an efficient earth wire
- If the wire and/or some other components are damaged, they must be immediately replaced with spare parts.
This should be done only by specialized people, to ensure product safety. INDA disclaims any liability for failure to comply with this obligation.
- The junction box must be built recessed into the wall. It must be made of insulated material and have a lid that closes completely. It also must have a protection level that is at least equal to that of the device.
- This article can be independently connected to the lighting line and the user socket line, in agreement with the regulations in force for electrical systems. Doubling the two systems solves the requirement in hotels of enabling sockets only if explicitly requested by the customer.
- Connect schuko plugs, with a similar degree of protection class of the instrument.
- Classification under EN 62471 'Exempt Group' for photo biological risks
- This article must be used only if complete with protection screen.
- Connect both the lamp and the power supply wires with a terminal strip E (2 poles 1,5mm min TA 25* IP44) and place them in the junction box.



Disposal of Waste Electrical and Electronic Equipment (WEEE) in the European Union.

This symbol appears on the product or on the packaging to indicate that the product must be collected separately. Users must arrange for the disposal of worn out equipment by taking it to the proper collection centre for recycling waste electrical and electronic equipment. Separate collection and recycling of worn out equipment during the disposal process favours the conservation of natural resources and guarantees safe disposal of said equipment protecting both the environment and human health. For more information on the collection centres for worn out equipment, contact the sales outlet where the product was purchased.

CLEANING

Quality, technological processes and materials are the features that determine the high standards of our accessories. However, to avoid surface alterations, it is necessary to follow a few guidelines. Clean all finishes exclusively with soap and water, and dry with a soft cloth. Do not use coarse cloths, abrasive products, acids, ammonia products, caustic substances, bleach or solvents.

In case of contact with these substances, rinse surfaces immediately and wipe dry. Remember that even fumes can damage metal. Wash accessories next to the toilet bowl at regular intervals to avoid corrosion.



L'installazione e il collegamento elettrico devono essere eseguiti solo da personale specializzato. Attenersi scrupolosamente alle prescrizioni impiantistiche e di installazione previste nel paese in cui viene installato il prodotto.

ATTENZIONE

- L'apparecchio deve essere protetto ad un interruttore differenziale con $I_{\Delta n} \leq 30\text{mA}$
- Prima di qualsiasi operazione (pulizia-sostituzione delle lampadine-installazione dell'apparecchio) togliere sempre tensione dall'impianto.
- Prima di effettuare l'installazione verificare che la posizione scelta sia conforme alle distanze di sicurezza previste dalle normative del paese dove viene installato l'apparecchio
- Il foglio istruzioni deve essere conservato e consegnato al personale addetto alla pulizia / manutenzione
- L'apparecchio è adatto solo per uso interno.
- Collegare l'apparecchio ad un cavo di messa a terra efficiente.
- Se il cavo di alimentazione e/o altri componenti sono danneggiati devono essere immediatamente sostituiti con pezzi di ricambio l'operazione deve essere eseguita solo da personale specializzato al fine di garantire la sicurezza del prodotto. INDA declina ogni responsabilità per il mancato rispetto del suddetto obbligo.
- La scatola di derivazione da predisporre nel muro, deve essere di materiale isolante, provvista di coperchio completamente chiuso e avere il grado di protezione almeno pari a quello dell'apparecchio.
- Lo specchio è predisposto per l'allacciamento indipendente alla linea di illuminazione e alla linea presa per utenza, in accordo con le normative vigenti per gli impianti elettrici. Lo sdoppiamento dei due impianti dà soluzione alla necessità che esiste negli alberghi e negli hotels, di abilitare le prese solo su esplicita richiesta del cliente.
- Collegare alla presa presente sull'apparecchio, spine schuko con grado di protezione pari a quello dell'apparecchio
- Classificazione secondo EN 62471 'Gruppo Esente' per i rischi fotobiologici.
- L'apparecchio deve essere usato solo se completo dello schermo di protezione.
- Collegare i cavi della lampada e quelli della rete di alimentazione a una scatola di connessione E (2 Poli min 1,5 mm TA 25° IP44) e introdurla nella scatola di derivazione



Smaltimento di rifiuti di apparecchiature elettriche ed elettroniche (RAEE) nell'Unione Europea.

Questo simbolo che appare sul prodotto o sulla confezione indica che il prodotto è soggetto a raccolta differenziata. Gli utenti devono provvedere allo smaltimento delle apparecchiature da rottamare portandole al luogo di raccolta indicato per il riciclaggio delle apparecchiature elettriche ed elettroniche. La raccolta e il riciclaggio separati delle apparecchiature da rottamare in fase di smaltimento favoriscono la conservazione delle risorse naturali e garantiscono che tali apparecchiature vengano rottamate nel rispetto dell'ambiente e della tutela della salute. Per ulteriori informazioni sui punti di raccolta delle apparecchiature da rottamare, contattare il rivenditore presso il quale è stato acquistato il prodotto.

PULIZIA

Qualità, processi tecnologici e materiali sono le caratteristiche che determinano l'alto livello dei nostri accessori. Comunque al fine di evitare alterazioni delle superfici è necessario seguire alcune avvertenze, pulendo qualsiasi finitura esclusivamente con acqua e sapone, asciugando con un panno morbido. Evitare stracci ruvidi, prodotti abrasivi, sostanze acide, ammoniacali, caustiche, candeggine, solventi e prodotti commerciali multiuso. Nel caso di contatto con tali sostanze occorre sciacquare ed asciugare subito le superfici. Ricordare che anche i vapori possono intaccare il metallo. Lavare periodicamente gli accessori vicino al wc per evitare corrosioni.



L'installation et le raccordement électrique doivent être effectués uniquement par du personnel spécialisé. S'en tenir scrupuleusement aux prescriptions en matière d'équipement et d'installation prévues dans le pays dans lequel le produit est installé.

ATTENTION

- L'appareil doit être protégé par un interrupteur différentiel avec $I_{\Delta n} \leq 30\text{mA}$
- Avant toute opération (nettoyage - remplacement des ampoules - installation de l'appareil), toujours couper la tension de l'installation.
- Avant d'effectuer l'installation, vérifier que la position est bien conforme aux distances de sécurité prévues par les réglementations du pays dans lequel le produit est installé.
- La feuille d'instructions doit être conservée et donnée au personnel chargé du nettoyage/entretien.
- L'appareil convient uniquement pour un usage en intérieur.
- Relier l'appareil à un câble conducteur à terre efficace.
- Si le câble et / ou d'autres pièces sont cassés ils doivent être immédiatement remplacés par des pièces de rechange. Ce ci doit être effectué uniquement par du personnel qualifié pour assurer la sécurité des produits. INDA décline toute responsabilité pour manquement à cette obligation.
- La boîte de dérivation à aménager dans le mur doit être réalisée dans un matériau isolant, équipée d'un couvercle complètement fermé et avoir un degré de protection au moins égal à celui de l'appareil.
- L'appareil est prévu pour le branchement indépendant à la ligne d'éclairage et à la ligne des prises servies conformément aux normes en vigueur applicables aux installations électriques. Cette séparation des deux circuits permet de répondre aux besoins de certains hôtels et autres établissements où les prises sont activées à la seule demande du client.
- Relier à la prise présente sur l'appareil, prise schuko avec degré de protection égale à celui de l'appareil
- Classification selon EN 62471 « Groupe Exempt » pour les risques photo biologiques.
- L'appareil doit être utilisé seulement avec la protection en plein écran.
- Connectez les fils de la lampe et de l'alimentation à une boîte de raccordement E (2 min 1,5 mm Poly TA 25 ° IP44) et mettez dans la boîte de jonction



Élimination des déchets d'équipements électriques et électroniques (DEEE) dans l'Union Européenne.

Ce symbole, présent sur le produit ou l'emballage, indique que le produit doit faire l'objet d'un ramassage sélectif. Les utilisateurs doivent procéder à l'élimination des équipements à mettre au rebut en les acheminant vers le lieu de ramassage indiqué pour le recyclage des équipements électriques et électroniques. Ramasser et recycler de façon séparée les équipements à mettre au rebut lors de la phase d'élimination permet de mieux préserver les ressources naturelles. Cela permet aussi de garantir que ces équipements soient mis au rebut dans le respect de l'environnement et de la protection de la santé. Pour plus d'informations sur les points de collecte des équipements à mettre au rebut, veuillez contacter le revendeur chez qui vous avez acheté le produit.

NETTOYAGE

Nos accessoires se distinguent par le niveau élevé de leur qualité, de leur processus technologiques et de leurs matériaux. Toutefois, afin d'éviter d'abîmer les surfaces, il est nécessaire de suivre certaines recommandations, en nettoyant toutes les finitions uniquement avec de l'eau et du savon, en les essuyant avec un chiffon doux. Éviter d'utiliser des chiffons rugueux, des produits abrasifs, des substances acides, ammoniacales, caustiques, de l'eau de Javel, des solvants et des produits commerciaux multi-usages.

En cas de contact avec ces substances, rincer et essuyer aussitôt les surfaces.

Ne pas oublier que même les vapeurs peuvent corroder le métal.

Laver régulièrement les accessoires à côté de la cuvette WC afin d'éviter toute corrosion.



Installation und Stromanschluss sind ausschließlich von Fachpersonal auszuführen.

Beachten Sie die Bestimmungen für Anlagen und Installationen, die in Ihrem Land vorgeschrieben sind.

ACHTUNG

- Das Gerät muss durch einen Schutzschalter mit Nennfehlerstrom $I_{\Delta n} \leq 30\text{mA}$ geschützt sein.
- Vor jeder Tätigkeit (Reinigung/Ersatz der Lampen/Installation der Leuchte) immer den Strom abschalten.
- Vor der Installation prüfen, dass die gewählte Position mit den im Installationsland vorgeschriebenen Sicherheitsabständen übereinstimmt.
- Die Anweisungen müssen aufbewahrt und dem für Reinigung und Wartung zuständigen Personal übergeben werden.
- Das vorgesehene Befestigungssystem ist nur für festes Mauerwerk geeignet.
- Das Gerät ist ausschließlich zum Gebrauch in Innenräumen vorgesehen.
- Das Gerät mit einem effizienten Kabel-Erdung verbinden.
- Wenn das Netzkabel und / oder andere Bestandteile beschädigt sind, müssen diese sofort durch Ersatzteile ersetzt werden. Dies sollte nur von geschultem Personal durchgeführt werden, um die Produktsicherheit zu gewährleisten. INDA übernimmt keinerlei Haftung für die Nichteinhaltung dieser Verpflichtung.
- Der in der Wand anzubringende Abzweigkasten muss aus Isoliermaterial und mit einem vollständig geschlossenen Deckel versehen sein und einen Schutzgrad aufweisen, der mindestens dem Schutzgrad des Gerätes entspricht.
- Das Gerät hat gemäß den geltenden Vorschriften für elektrische voneinander unabhängige Anschlüsse für Licht und Steckdose Einrichtungen. Durch die separate Ausführung der Anschlüsse besteht die Möglichkeit, wie etwa in Hotels, die Steckdosen nur auf ausdrücklichen Kundenwunsch zu aktivieren
- Schuko-Steckdosen mit dem selben Schutzgrad wie das Gerät mit der vorhandenen Steckdose verwenden
- Einstufung nach EN 62471: ° von photobiologischem Risiko freie Gruppe
- Das Gerät darf ausschließlich und nur mit Schutzblende verwendet werden.
- Schließen Sie die Kabel der Lampe und die der Netzversorgung an einen Stromversorgung an E (2 min 1,5 mm Poly TA 25 ° IP44) und legen sie ganz ganze in die Anschlussdose.



Entsorgung elektrischer und elektronischer Altgeräte (WEEE) in der Europäischen Gemeinschaft.

Dieses auf dem Produkt oder der Verpackung vorhandene Symbol weist darauf hin, dass das Produkt getrennt entsorgt werden muss. Die Benutzer müssen Geräte, die verschrottet werden sollen, zu den angegebenen Sammelstellen zum Recycling elektrischer und elektronischer Altgeräte bringen. Getrennte Sammlung und Recycling von Altgeräten zur Entsorgung fördern die Erhaltung der natürlichen Ressourcen und garantieren, dass diese Geräte gesundheits- und umweltgerecht verschrottet werden. Weitere Information zu den Sammelstellen für Altgeräte erhalten Sie von Ihrem Einzelhändler, bei dem sie das Produkt erworben haben.

REINIGUNG

Unserer Zubehörkomponenten zeichnen sich durch die hohe Qualität der Verfahrenstechniken und Materialien aus. Um Veränderungen der Oberflächen zu vermeiden, sind jedoch einige Hinweise zu beachten. Die Oberflächen dürfen nur mit Wasser und Seife gereinigt und müssen anschließend mit einem weichen Tuch abgetrocknet werden. Raue Lappen, Scheuermittel, säure- und ammoniakhaltige Mittel, Ätzmittel, Chlorbleiche sowie handelsübliche Vielzweck-Lösungsmittel sind zu vermeiden. Sollten die Oberflächen mit diesen Stoffen in Berührung kommen müssen sie sofort abgespült und abgetrocknet werden. Denken Sie daran, dass auch Dämpfe Metall angreifen können. Zur Vermeidung von Korrosion sind Zubehörteile in WC-Nähe regelmäßig abzuspülen.



De installatie en de elektrische verbindingen mogen alleen worden uitgevoerd door gespecialiseerd personeel. Men dient zich strikt te houden aan de voorschriften betreffende installeringen en van installatie die gelden in het land waarin het product wordt geïnstalleerd.

LET OP

- De apparatuur moet worden beschermd door een differentieelschakelaar met $I_{\Delta n} \leq 30\text{mA}$
- Voordat men welke handeling dan ook gaat uitvoeren (schoonmaken-ervangen van lampen, installatie van het apparaat) altijd de stroom van de installatie uitschakelen.
- Voordat men de installatie uitvoert, ervoor zorgen dat de locatie van uw keuze voldoet aan de vereiste veiligheidsafstanden volgens de voorschriften van het land waarin het product wordt geïnstalleerd.
- De handleiding moet worden bewaard en geleverd aan het personeel dat belast is met schoonmaak/onderhoud.
- Het geleverde bevestigingssysteem is alleen geschikt op gebruikt te worden op volle muren of baksteenmuren.
- De apparatuur is alleen geschikt voor gebruik binnenshuis.
- Verbind de apparatuur aan een efficiënt geaarde kabel.
- Indien de voedingskabel en/of andere componenten beschadigd zijn, moeten deze onmiddellijk vervangen worden met andere onderdelen. De vervanging mag alleen uitgevoerd worden door gespecialiseerde technicus om zodoende de veiligheid van het produkt te verzekeren. INDA weigert de verantwoordelijkheid op zich te nemen mits deze verplichting niet uitgevoerd wordt.
- De vertakkingdoos die in de muur moet worden geplaatst, moet van isolerend materiaal zijn, voorzien van een volledig gesloten deksel en een beschermingsgraad die ten minste gelijk is aan die van het apparaat.
- De armatuur is voorbereid voor een onafhankelijke aansluiting op het elektriciteitsnet en op een stopcontact, in overeenstemming met de geldende wetgeving inzake elektrische installaties. Door splitsing van de twee installaties is het mogelijk, bijvoorbeeld in restaurants of hotels, om de stopcontacten alleen te activeren op uitdrukkelijk verzoek van de klant.
- De stopcontact van de apparatuur aansluiten; schuko stopcontact met dezelfde veiligheids graad als die van de apparatuur.
- Classificatie volgens EN 62471 ' Groep vrij van' fotobiologische risico's
- De armatuur mag alleen gebruikt worden samen met het scherm ter bescherming.
- De kabels van de lamp en de kabels van de stroomvoorziening met elkaar verbinden met behulp van een schakeldoos E (polen min. 1,5 mm TA 25° IP44) en invoeren in de aftakkingdoos



Verwijdering van afval van elektrische en elektronische apparatuur (RAEE) in de Europese Unie.

Dit symbool dat vermeld staat op het product of op de verpakking geeft aan dat het product via een gescheiden afvalverwerkingsstelsel verwijderd moet worden.

De gebruikers moeten er zorg voor dragen dat de te verwijderen apparatuur terecht komt op de plaats die is aangewezen voor recycling van elektrische en elektronische apparatuur. De gescheiden inzameling en hergebruik van apparatuur die wordt weggegooid is gunstig voor het behoud van de natuurlijke grondstoffen en garandeert dat deze apparaten worden verwijderd met respect voor het milieu en de zorg voor de gezondheid. Voor meer informatie over de plaatsen waar apparatuur ingezameld wordt kunt u contact opnemen met de leverancier waar u het product heeft gekocht.

REINIGING

Kwaliteit, technologische processen en materialen zijn de kenmerken die het hoge niveau van onze accessoires bepalen. Het is hoe dan ook noodzakelijk om, teneinde verandering van de oppervlakken te voorkomen, de aanwijzingen op te volgen, en alle afwerkingen uitsluitend met water en zeep schoon te maken en te drogen met een zachte doek. Gebruik geen ruwe doekjes, schuurmiddelen, zure, ammoniakhoudende of bijtende stoffen, bleekmiddelen, oplosmiddelen en multifunctionele reinigingsproducten. Als de oppervlakken hiermee in aanraking komen moet men ze onmiddellijk afspoelen en drogen.

Bedenk dat ook dampen het metaal kunnen aantasten. Reinig de accessoires in de buurt van de wc regelmatig om corrosie te voorkomen.



La instalación y conexión eléctrica deben ser efectuadas solamente por personal especializado. Seguir atentamente las indicaciones y normativas en vigor en el país donde se instala el producto

ATENCIÓN

- El aparato tiene que estar protegido para un interruptor diferencial con $I_{\Delta n} \leq 30\text{mA}$
- Antes de cualquier operación (limpieza, sustitución de bombilla, instalación del aparato) siempre quitar la tensión de la red.
- Antes de efectuar la instalación asegurarse de que la posición elegida sea conforme a las distancias de seguridad previstas por las normativas en vigor en el país donde se instala el producto.
- La hoja de instrucciones tiene que ser conservada y entregada al personal que se encarga de la limpieza y la manutención
- El sistema de fijación suministrado es apto solamente para instalar en pared de ladrillo (no pladur).
- Este aparato es conforme solo para uso interno.
- Ligar o aparelho a um fio de terra eficiente.
- Si el cable de alimentación y/u otros componentes estuviesen dañados, deberán ser reemplazados inmediatamente con repuestos válidos. Esta operación deberá ser realizada únicamente por personal calificado en modo de garantizar la seguridad del producto. INDA se exime de toda responsabilidad en caso de omisión de dicho requisito.
- La caja de derivación que se habrá de predisponer en la pared debe ser de material aislante, con tapa completamente cerrada y con un grado de protección que sea como mínimo del mismo nivel que el del aparato.
- Este aparato es apto para la conexión independiente a la línea de iluminación y a la línea de tomas para usuarios, de acuerdo con la normativa vigente para las instalaciones eléctricas. La separación de las dos instalaciones soluciona la necesidad, que existe en pensiones y hoteles, de habilitar las tomas sólo cuando requerido por el cliente.
- Conectar a la toma incluida en el aparato, un enchufe schuko con el mismo grado de protección
- Clasificación según EN62471: Grupo exente de riesgos foto-biológicos
- El aparato sólo se deberá usar con su pantalla de protección.
- Efectuar a ligação dos fios com a corrente eléctrica entre o terminal E (2 pólos 1,5mm min TA25* IP44) e colocá-los dentro do nicho da parede.



Eliminación de residuos de aparatos eléctricos y electrónicos (RAEE) dentro la Unión Europea

Este símbolo que aparece sobre el producto o la caja indica que el producto es objeto de recogida diferenciada. Los usuarios tengan que asumirse la responsabilidad de eliminar los aparatos que se eliminan llevándolos a un lugar de recogida indicado para la Eliminación de residuos de aparatos eléctricos y electrónicos. La recogida y eliminación separata. En fase de eliminación favorezcan la conservación de los recursos naturales y garantizan que tales aparatos sean eliminados en el respeto del medio ambiente y la tutela de la salud. Para obtener más informaciones referente la recogida de los aparatos para eliminar, contactar el vendedor donde se ha comprado el producto.

LIMPIEZA

Calidad, procesos tecnológicos y materiales son los factores que determinan el elevado nivel de nuestros accesorios. De todas formas, para evitar que se alteren las superficies es preciso seguir algunos consejos: para limpiar cualquier tipo de acabado se usará exclusivamente agua y jabón, secándolo después con un paño suave.

No se habrán de usar trapos ásperos, productos abrasivos, sustancias ácidas, amoniacales, cáusticas, lejía, disolventes ni tampoco productos comerciales multiuso.

En caso de contacto con dichas sustancias habrá que aclarar y secar inmediatamente las superficies.

Recuérdese también que los vapores pueden afectar a los metales.

Límpiese periódicamente los accesorios cercanos al wc para evitar corrosiones.

1

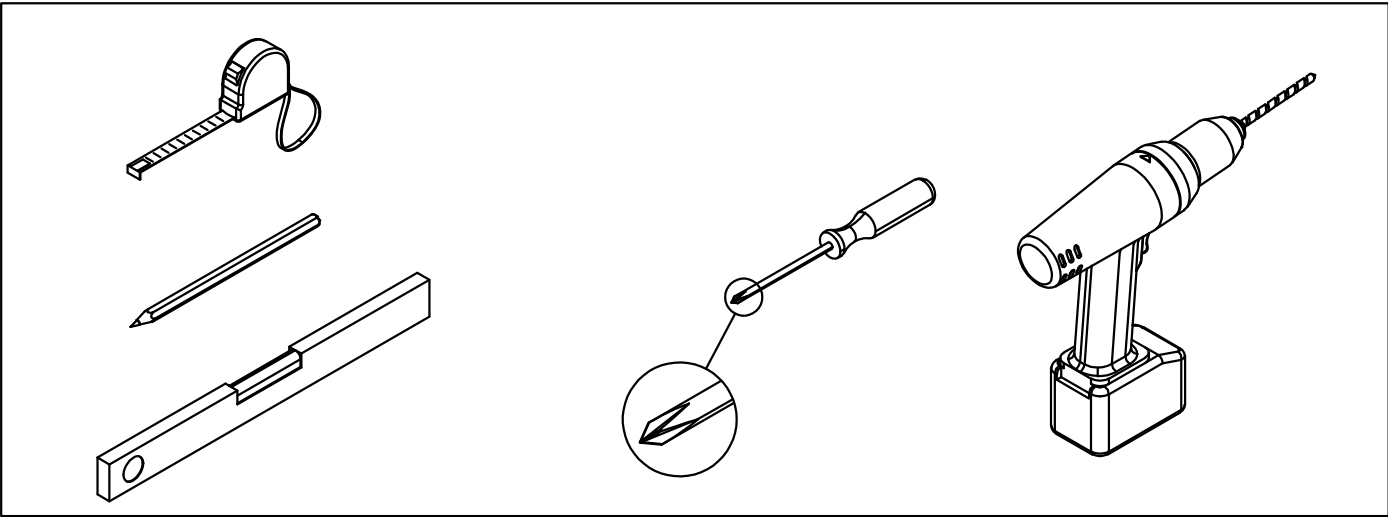
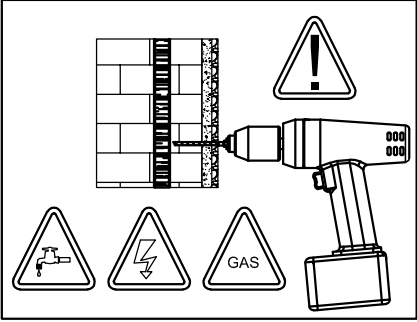
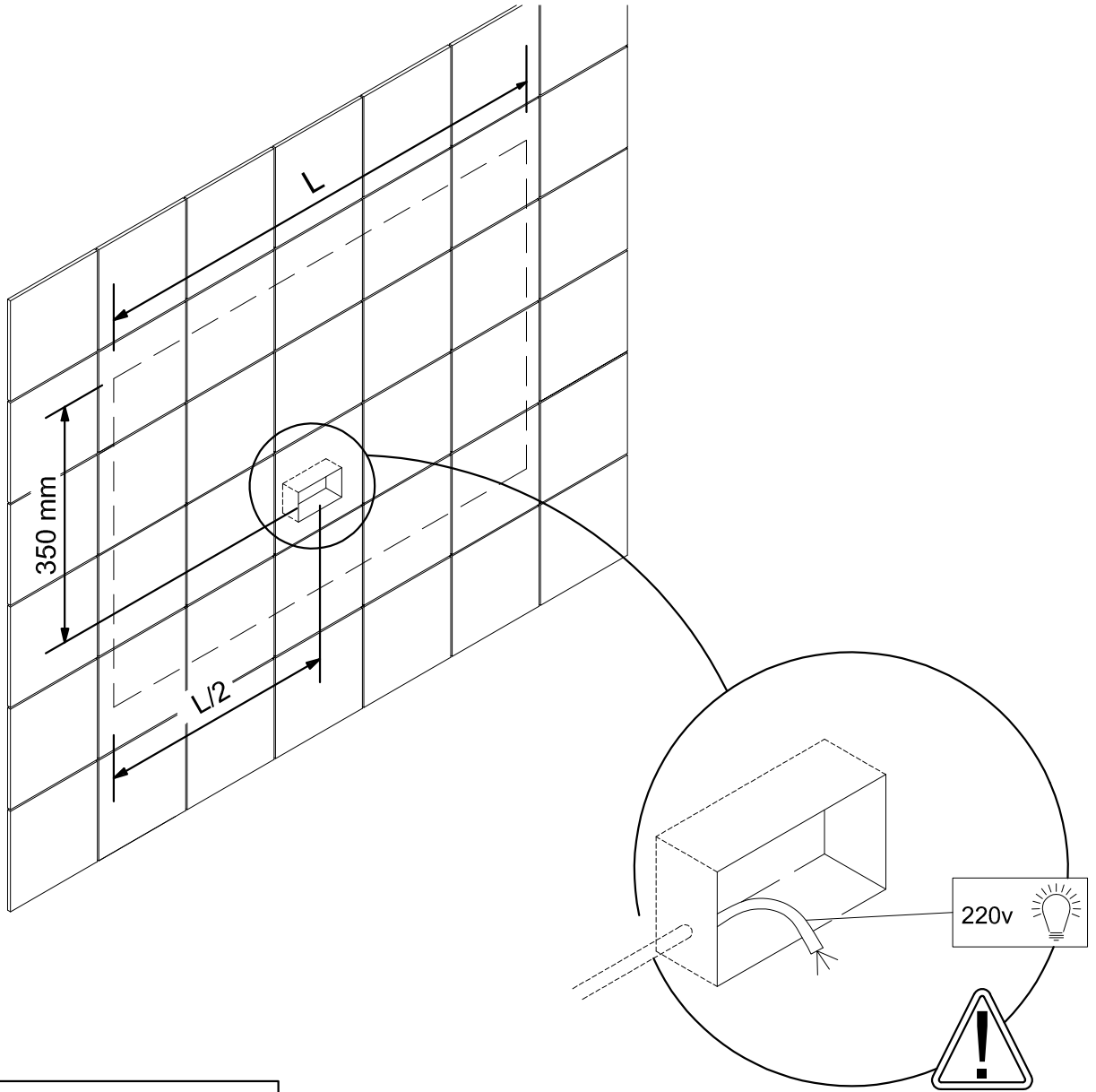

2

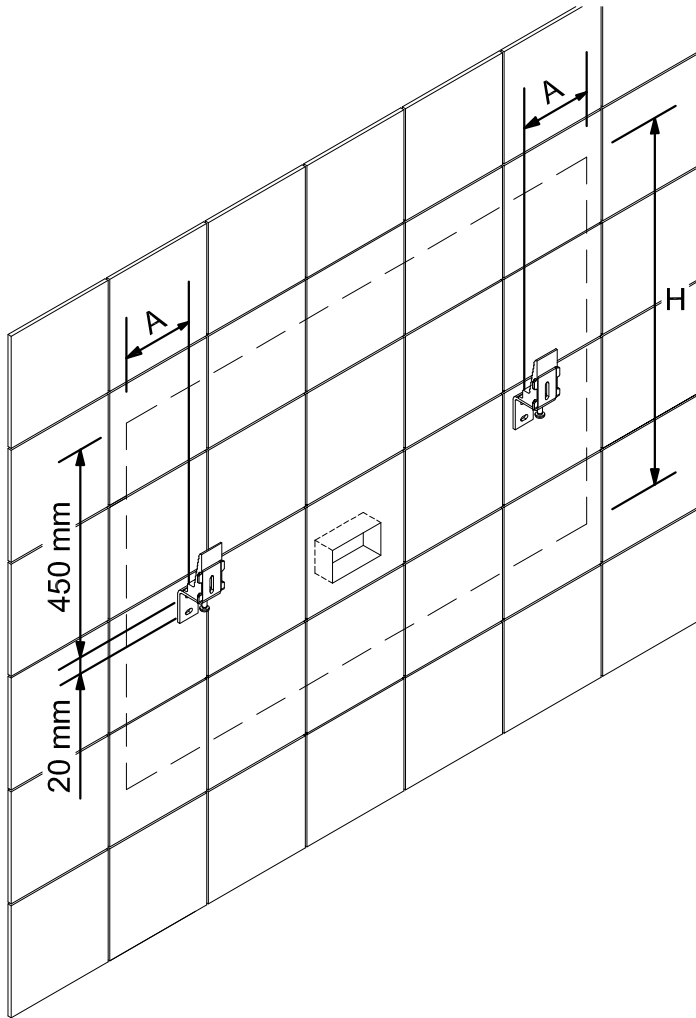

ART.	A	H
S9114	73	800
S9212	67	800
S9312	67	804
S9412	67	804
S9512	67	804
S9612	67	802
S9712	67	802
S9813	67	804

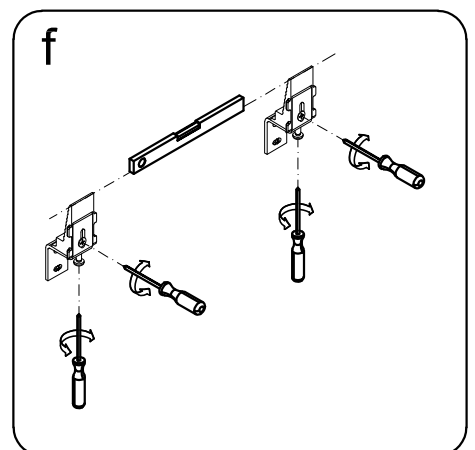
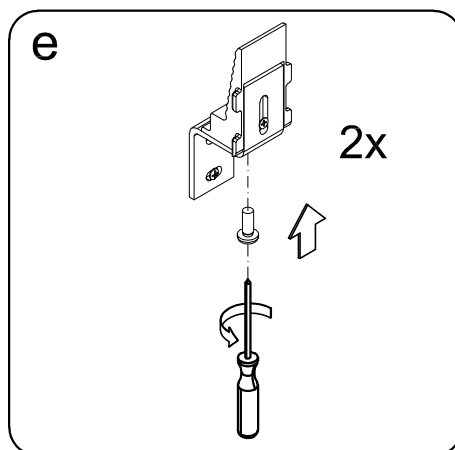
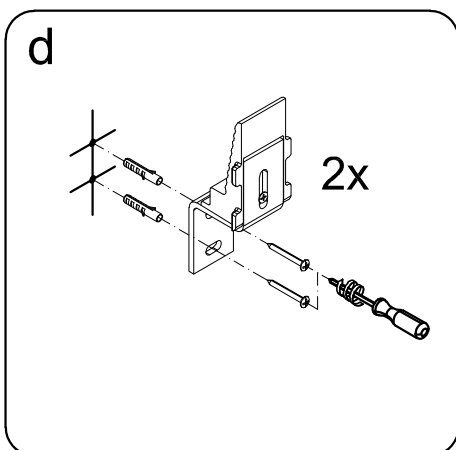
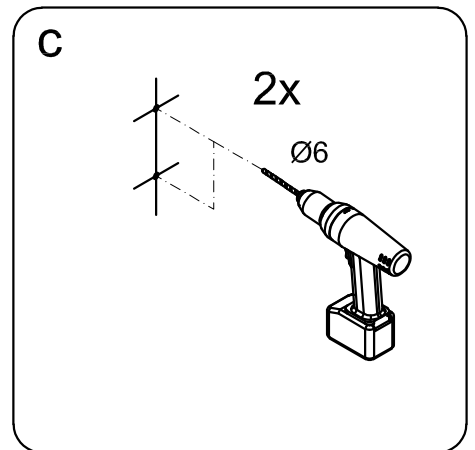
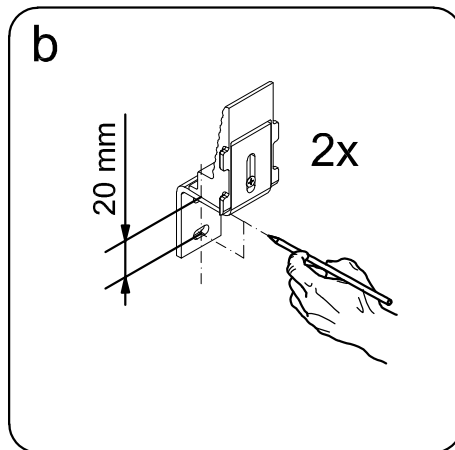
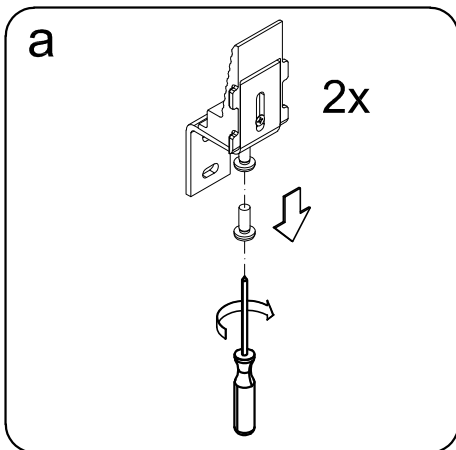

3

S9114

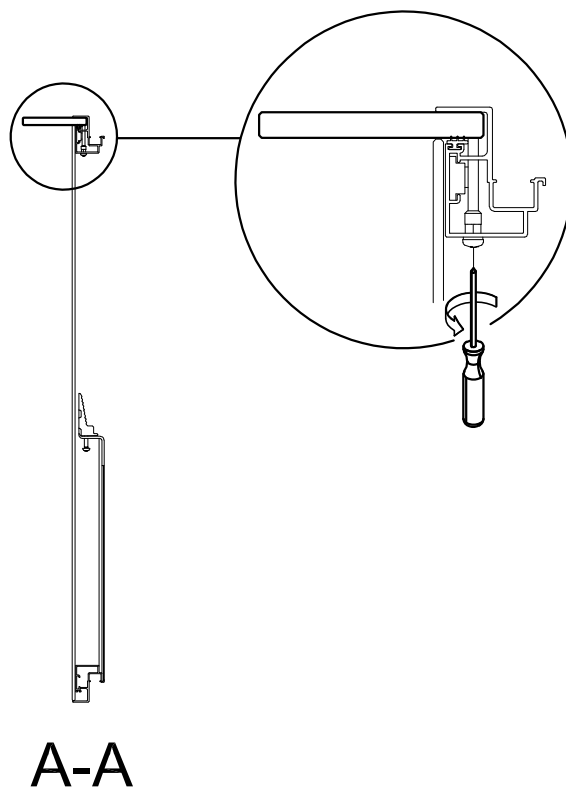
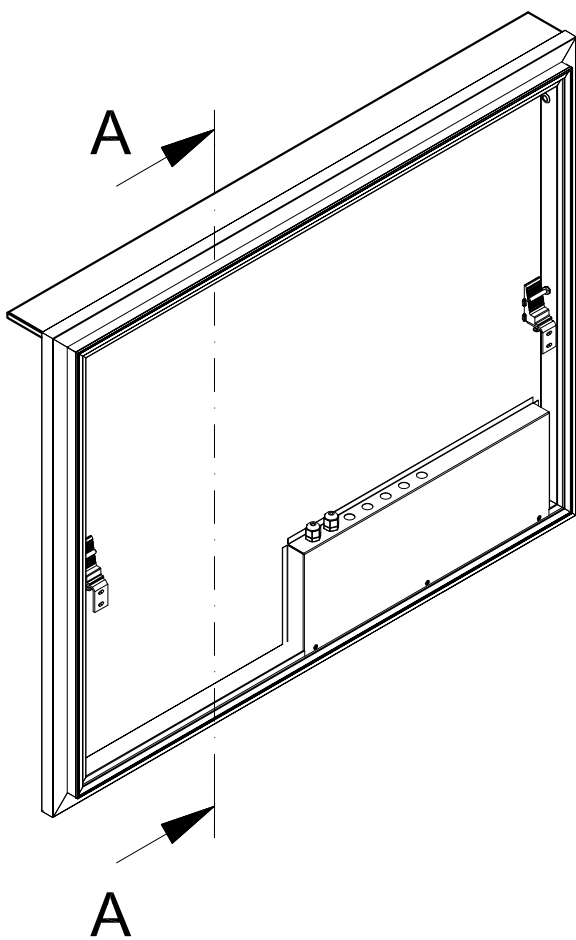
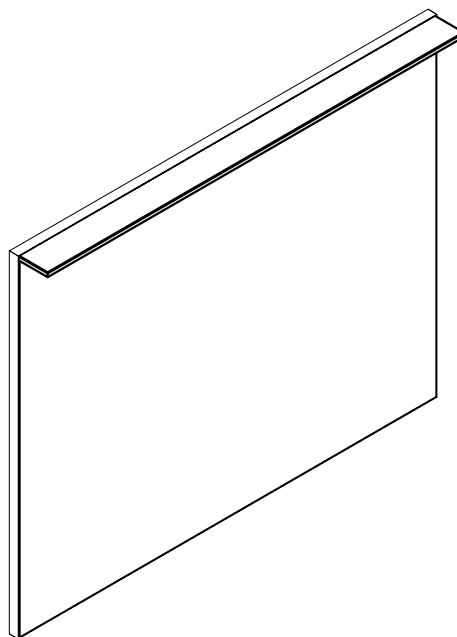
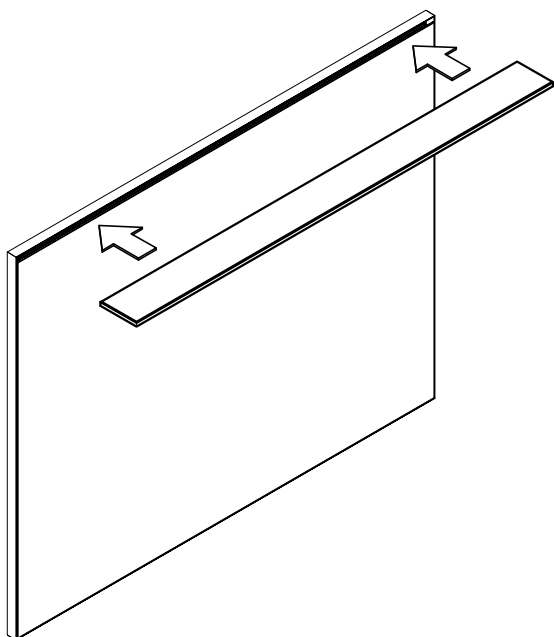

4

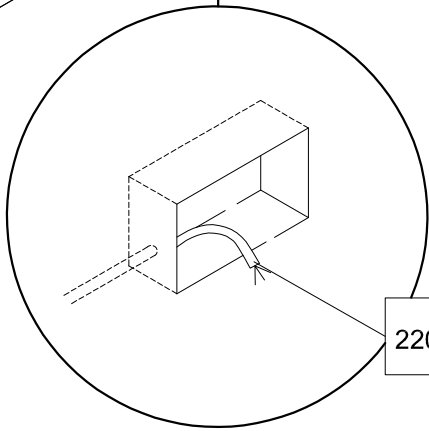
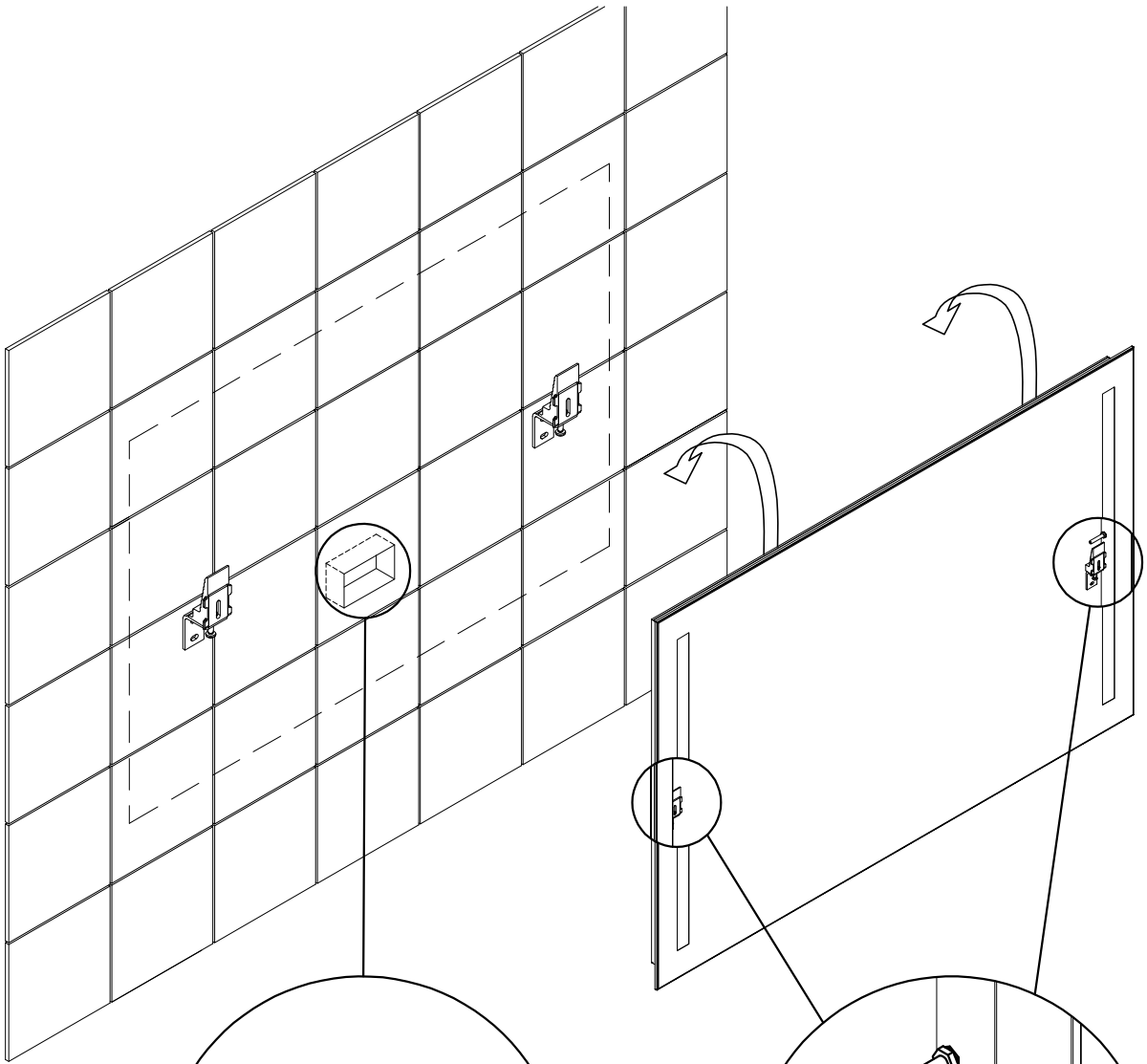

220v 

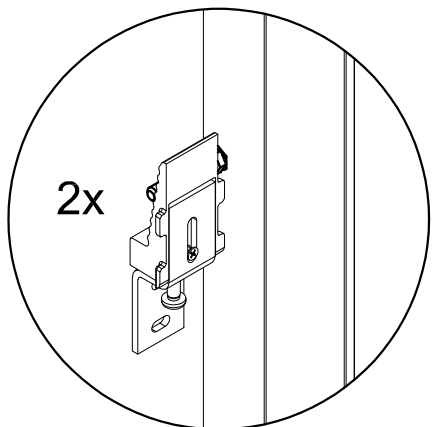
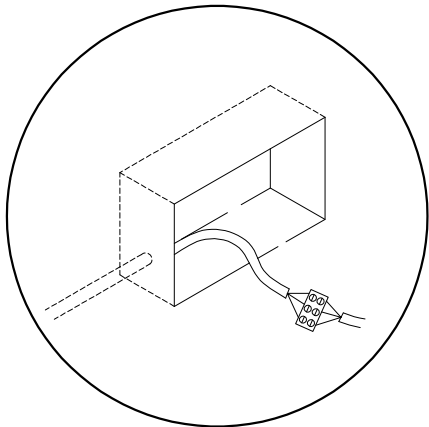
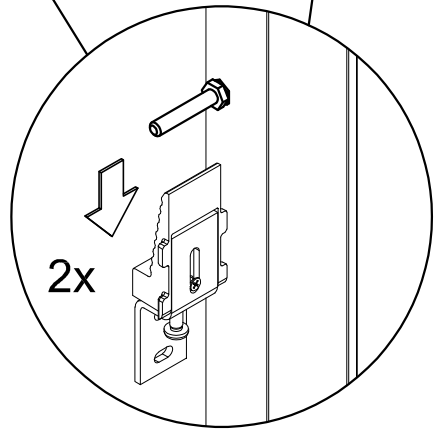

- I Allacciamento elettrico con linea luce sempre alimentata
- D Stromanschluss mit Lichtleitung immer stromversorgt
- E Conexión eléctrica con línea de luz siempre alimentada.
- GB Electric connection with light line always powered.
- FR Connexion électrique avec circuit d'éclairage toujours alimentées.
- NL Elektrische aansluiting met verlichtingscircuit altijd onder stroom.

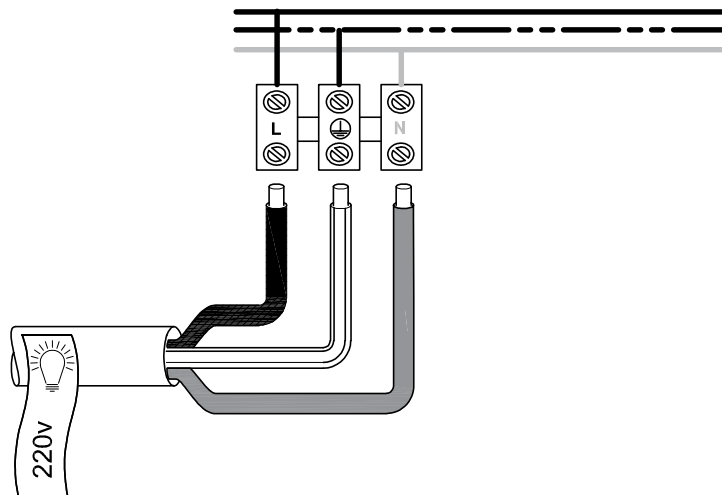

- I Allacciamento elettrico con linea prese sempre alimentata e linea luce interrotta da pulsante esterno
- D Stromanschluss mit Lichtleitung gesteuert durch Raumschalter
- E Conexión eléctrica con línea de luz interrumpida por botón externo
- GB Electric connection with light line interrupted by external button
- FR Connexion électrique avec circuit d'éclairage interrompue par interrupteur externe.
- NL Elektrische aansluiting met verlichtingscircuit onderbroken door externe schakelaar.

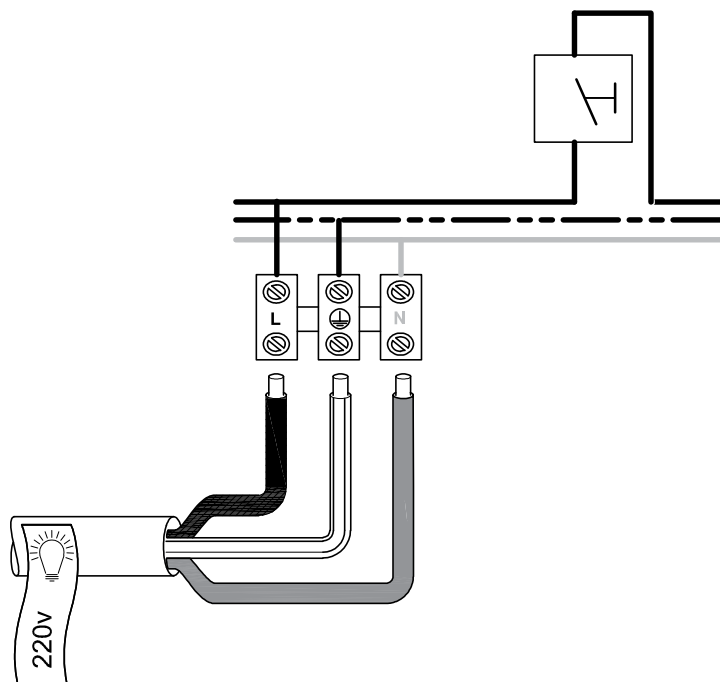

S9512

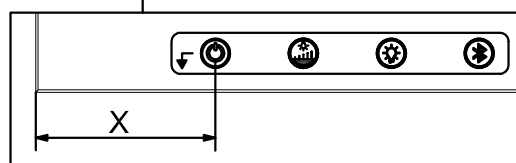
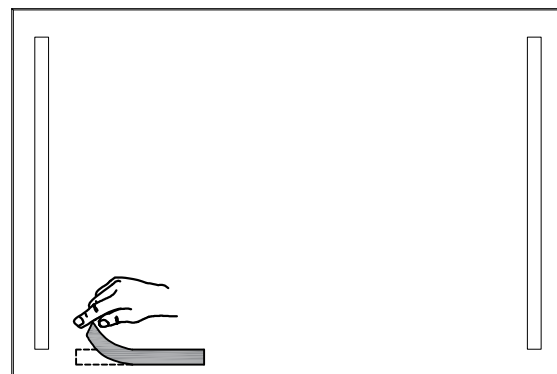
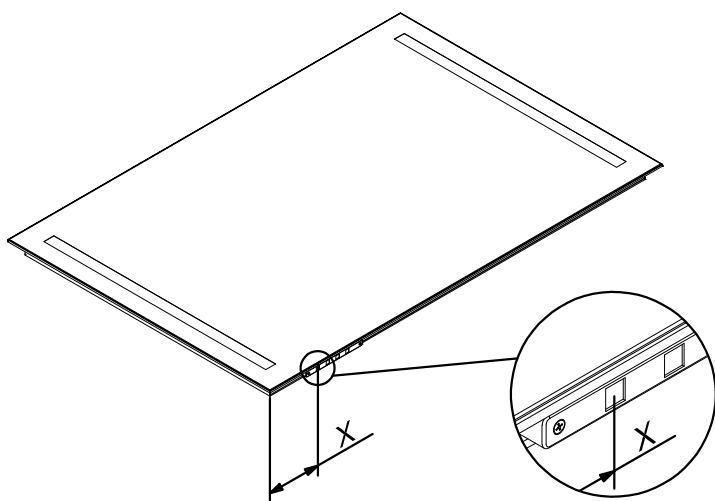

S9512---



S9512--RA---

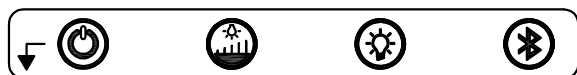

S9512--BT---

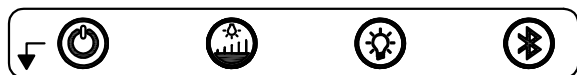

S9512--RABT--

S9512---

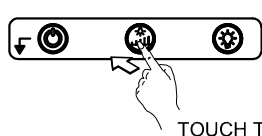
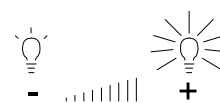
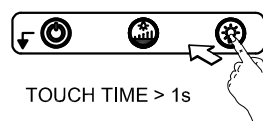
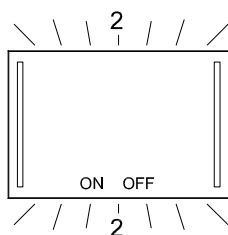
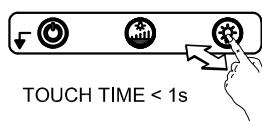
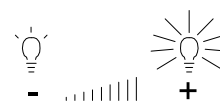
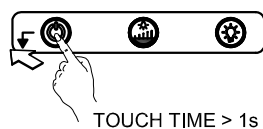
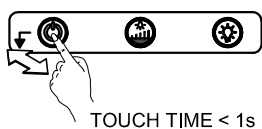

S9512--RA---

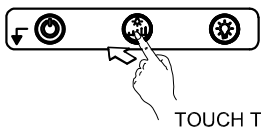
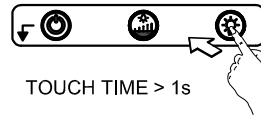
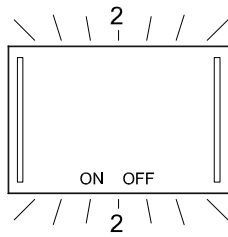
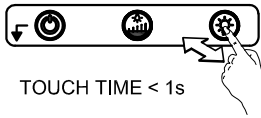
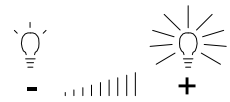
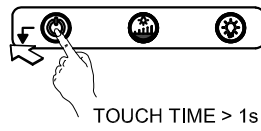
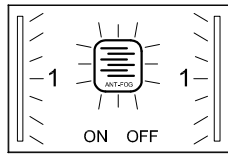
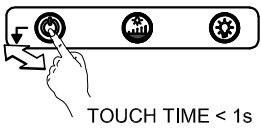

S9512--BT---

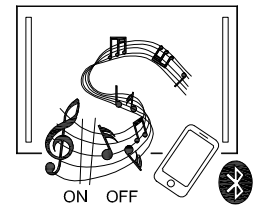
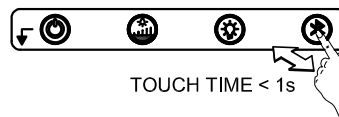
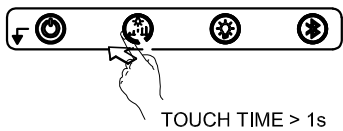
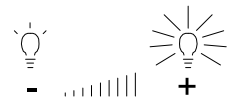
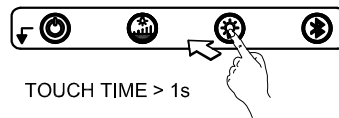
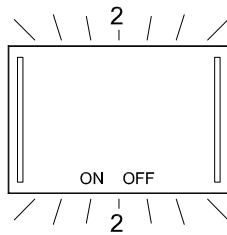
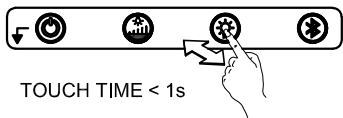
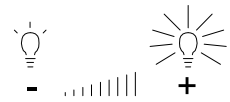
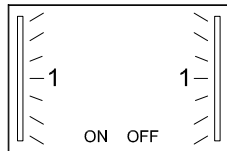
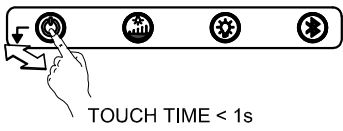

S9512--RABT--

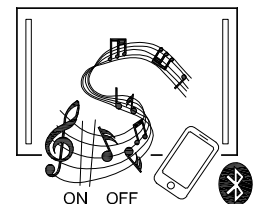
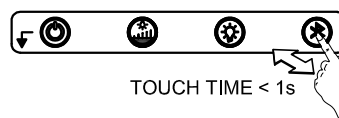
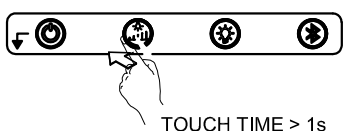
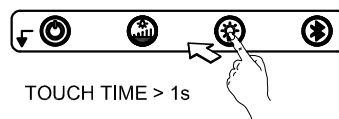
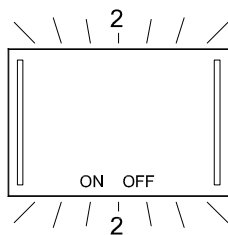
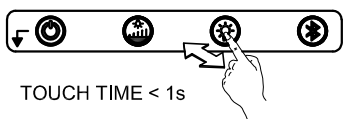
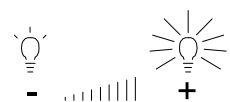
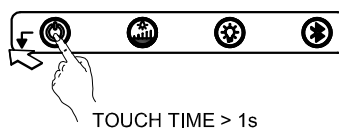
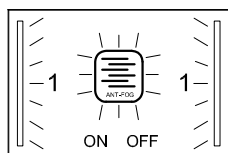
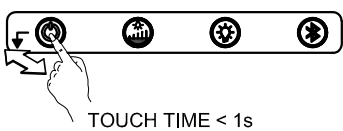

S9612

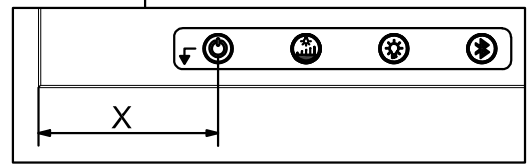
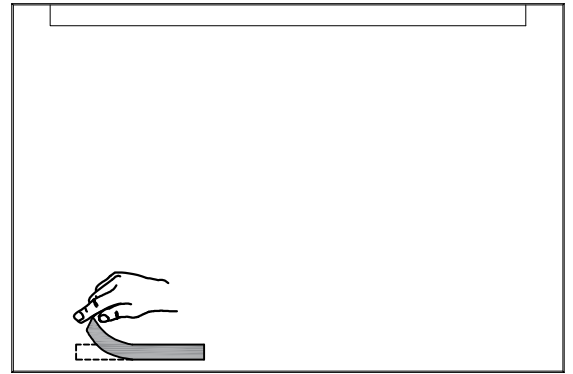
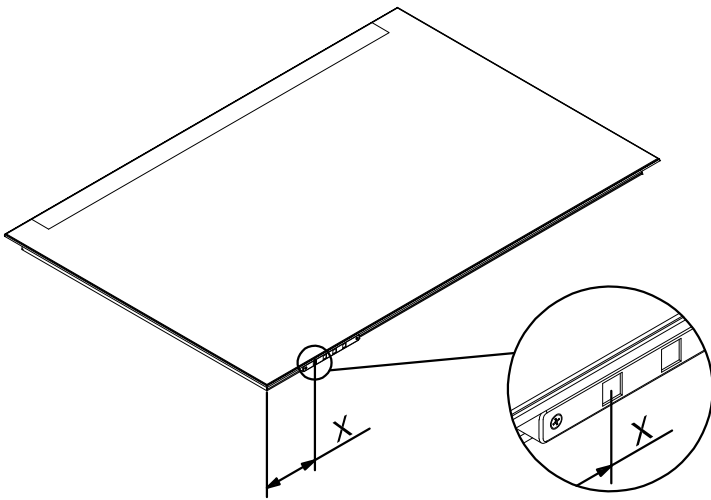

S9612---



S9612--RA---



S9612--BT---



S9612--RABT--

S9612---

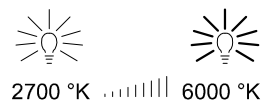
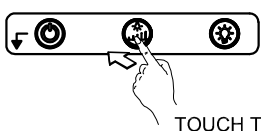
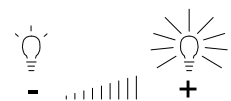
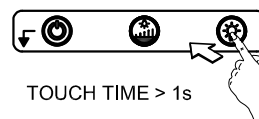
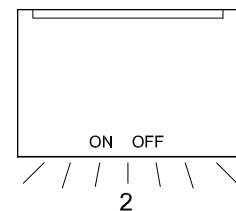
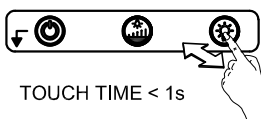
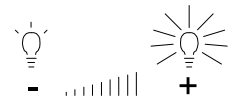
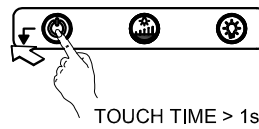
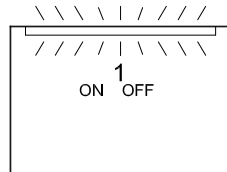
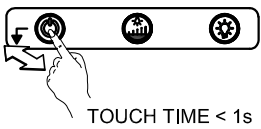

S9612--RA---

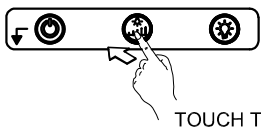
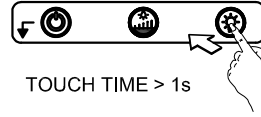
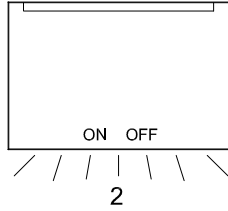
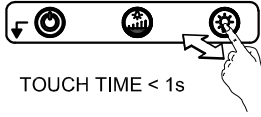
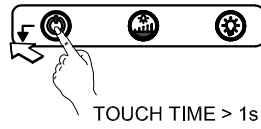
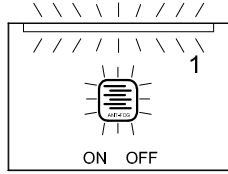
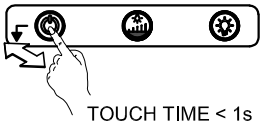

S9612--BT---

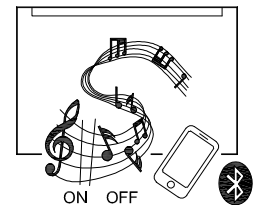
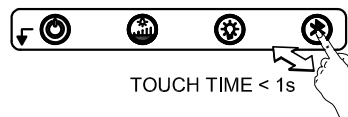
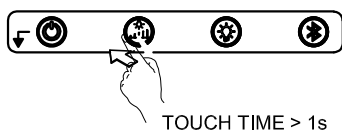
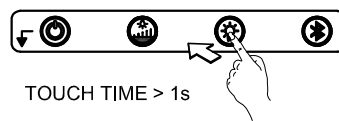
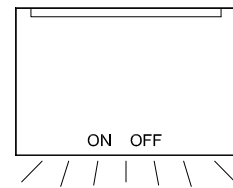
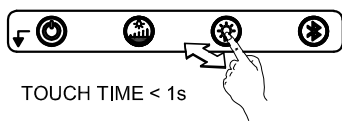
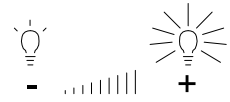
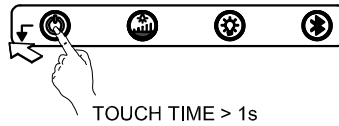
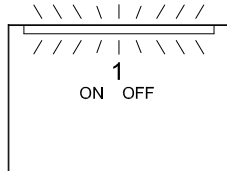
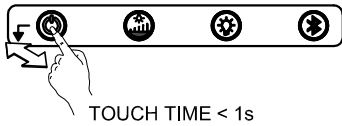

S9612--RABT--

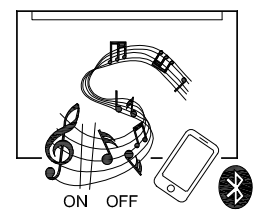
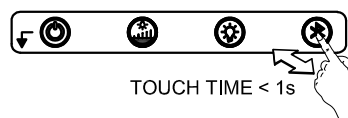
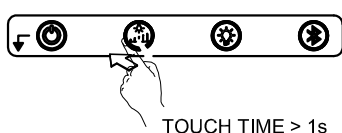
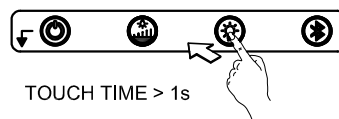
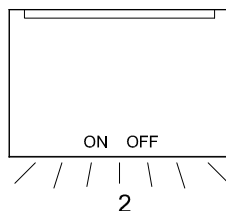
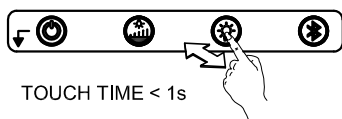
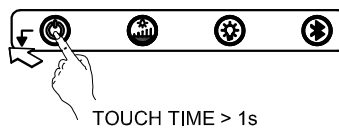
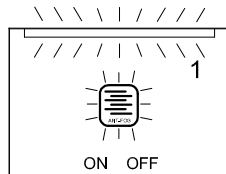
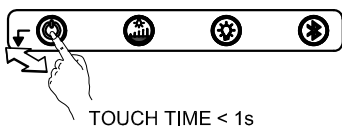

S9114

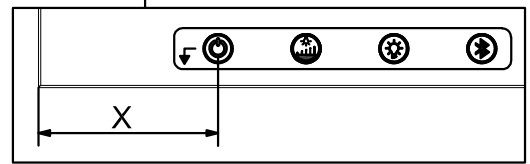
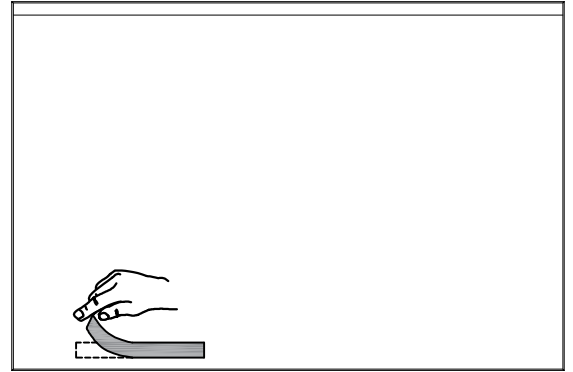
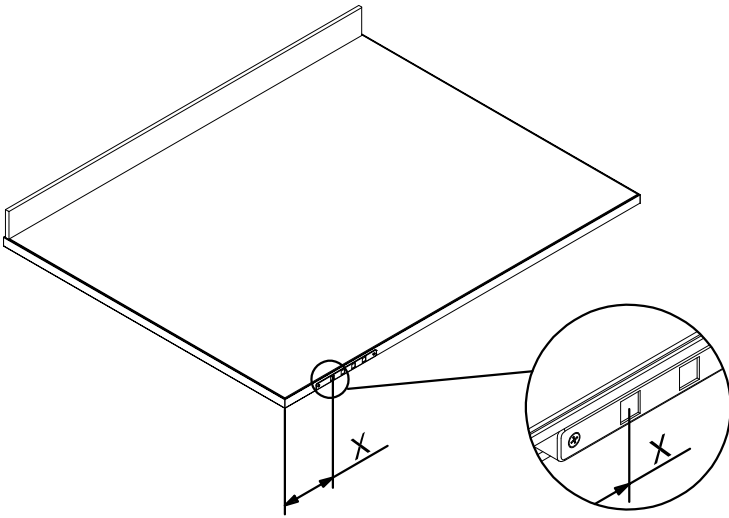

S9114---



S9114--RA---



S9114--BT---



S9114--RABT--

S9114---

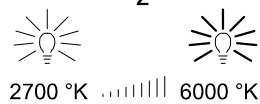
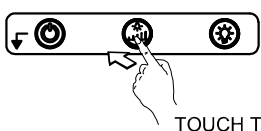
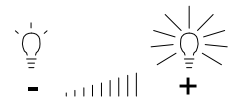
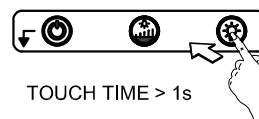
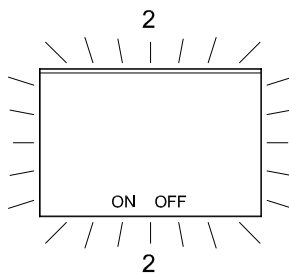
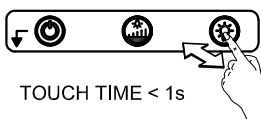
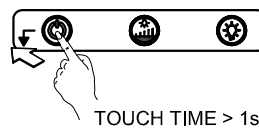
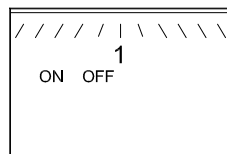
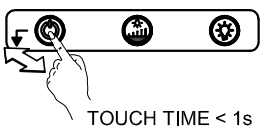

S9114--RA---

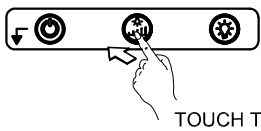
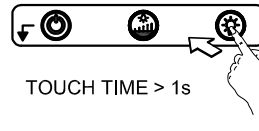
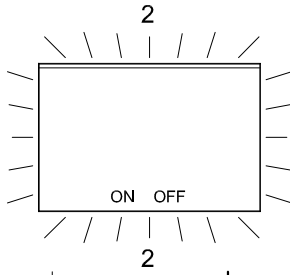
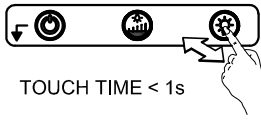
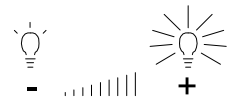
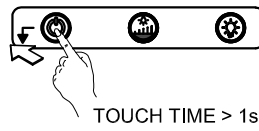
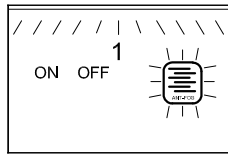
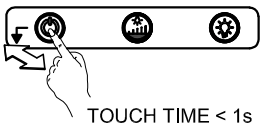

S9114--BT---

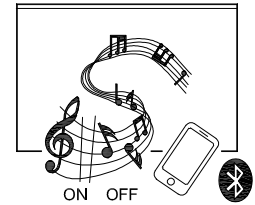
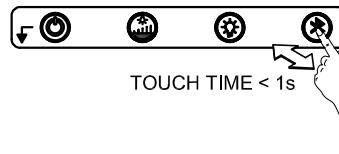
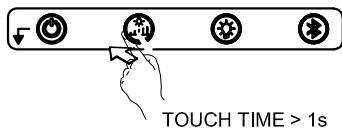
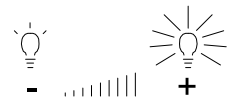
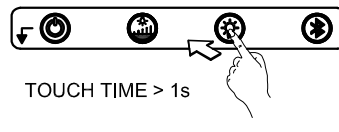
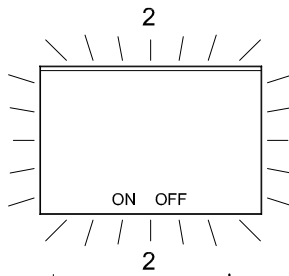
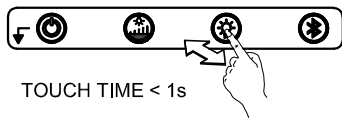
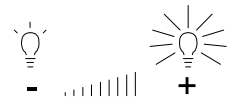
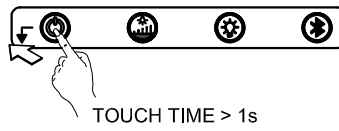
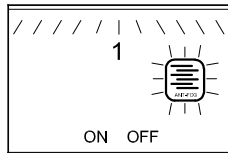
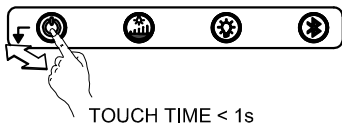

S9114--RABT--

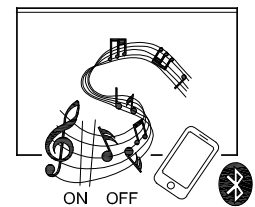
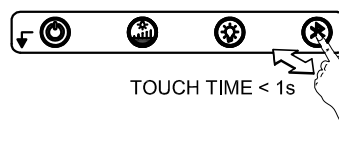
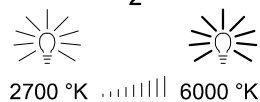
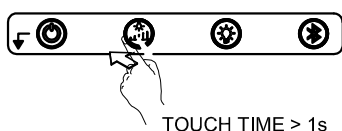
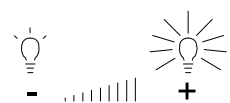
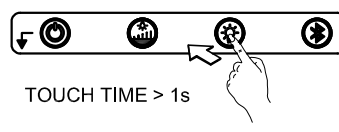
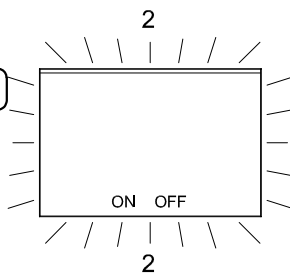
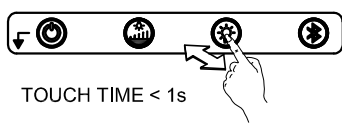
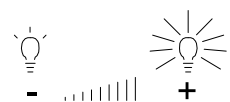
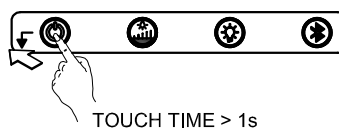
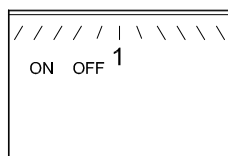
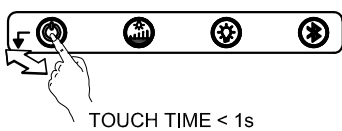

S9412

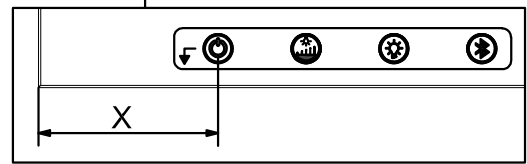
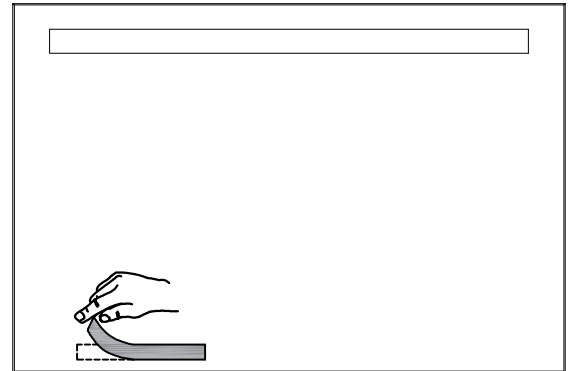
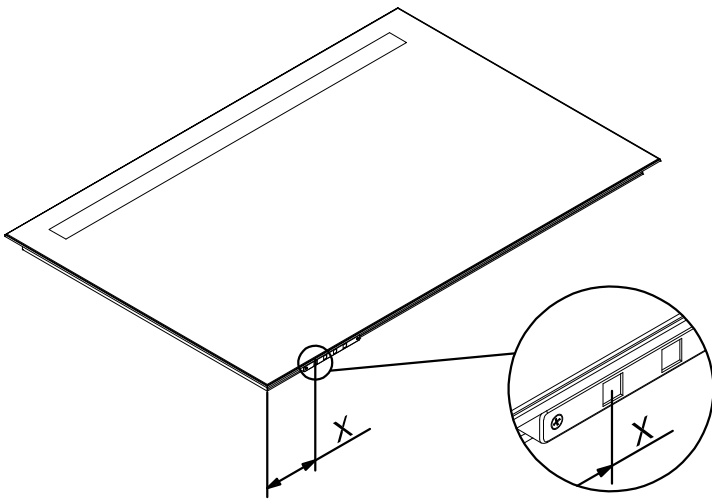

S9412---



S9412--RA---



S9412--BT---



S9412--RABT--

S9412---

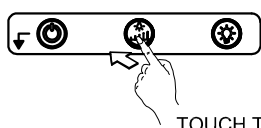
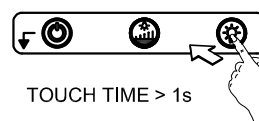
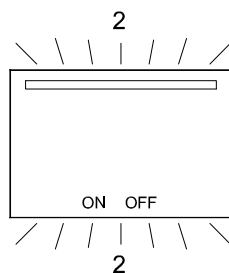
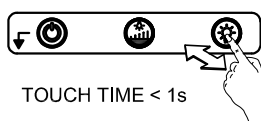
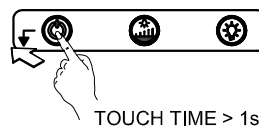
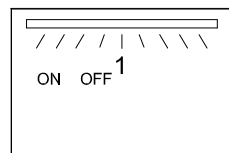
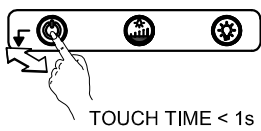

S9412--RA---

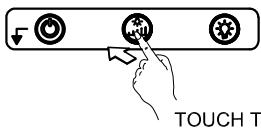
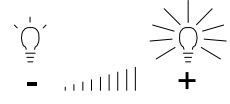
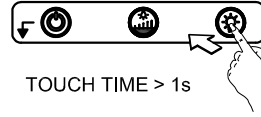
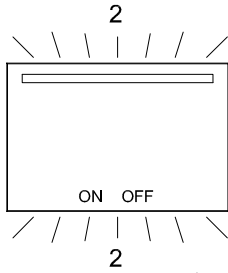
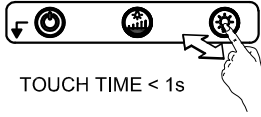
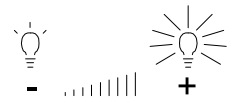
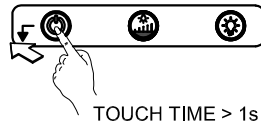
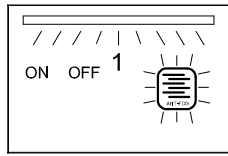
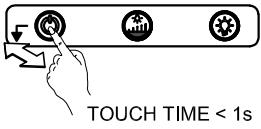

S9412--BT---

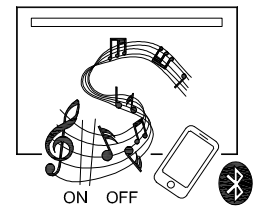
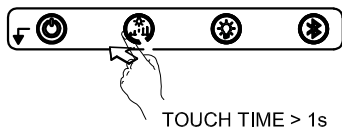
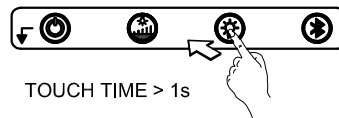
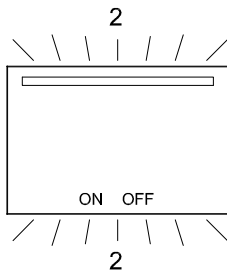
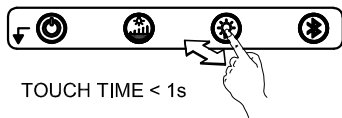
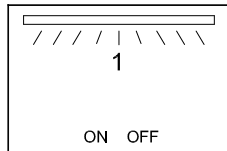

S9412--RABT--

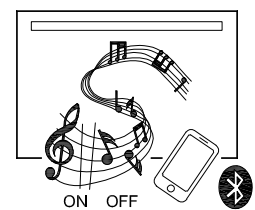
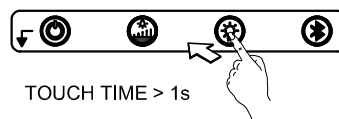
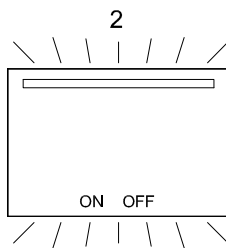
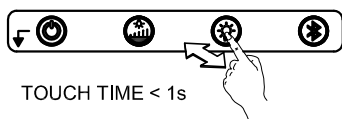
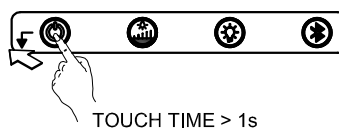
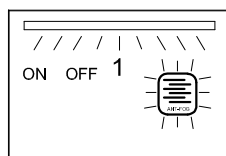
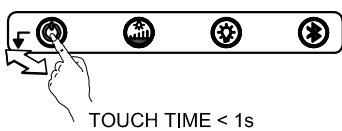

S9712

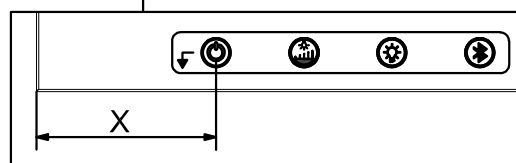
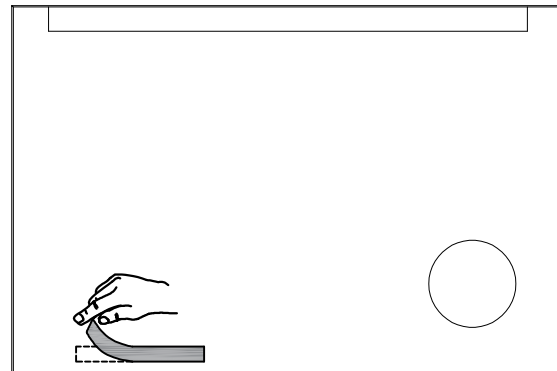
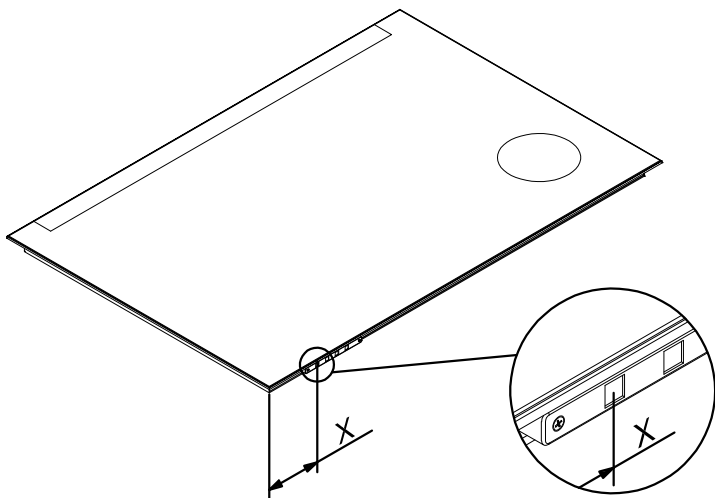

S9712---



S9712--RA---

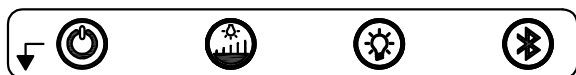

S9712--BT---

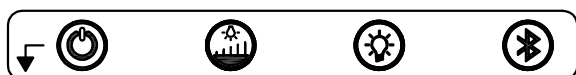

S9712--RABT--

S9712---



TOUCH TIME < 1s

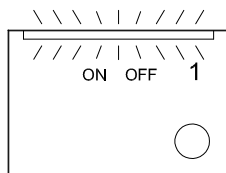

TOUCH TIME > 1s

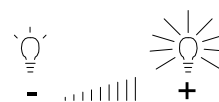

TOUCH TIME < 1s

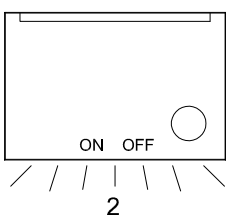

TOUCH TIME > 1s

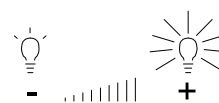

TOUCH TIME > 1s



S9712--RA---

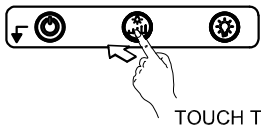
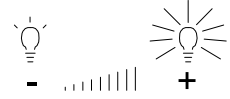
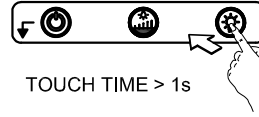
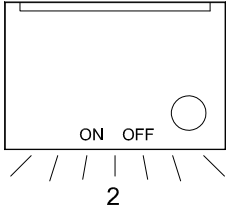
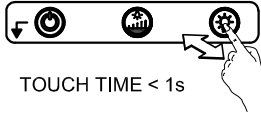
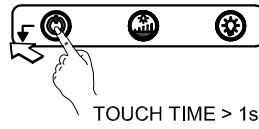
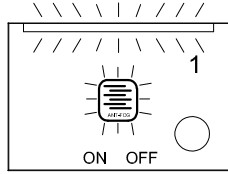
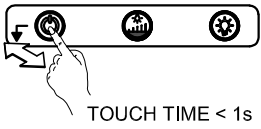

S9712--BT---

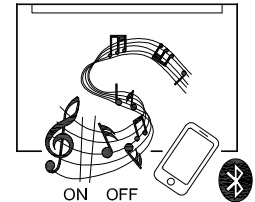
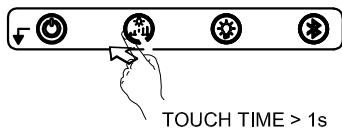
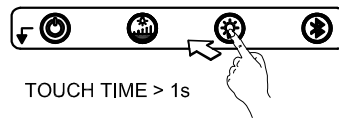
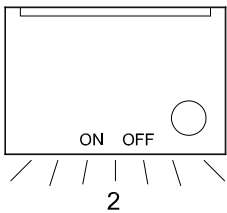
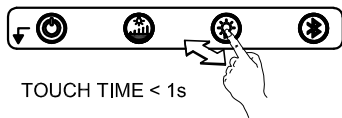
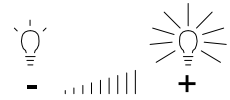
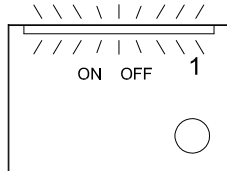

S9712--RABT--

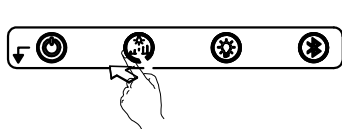
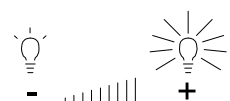
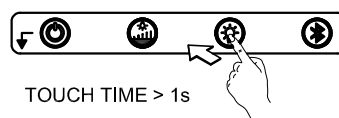
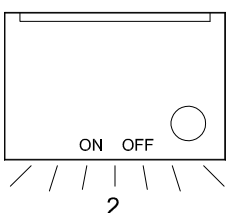
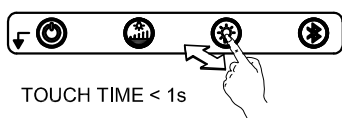
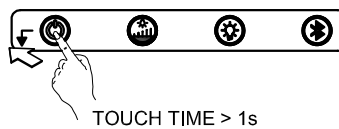
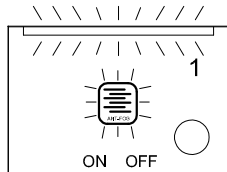
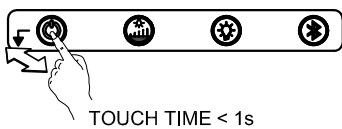

S9212

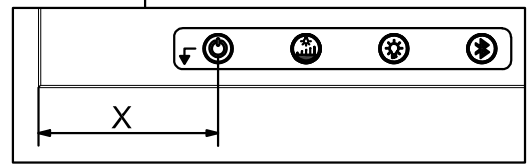
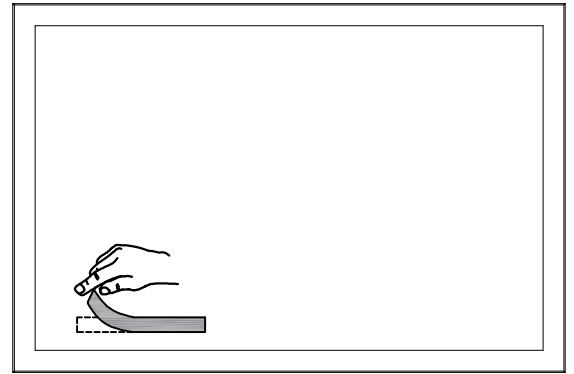
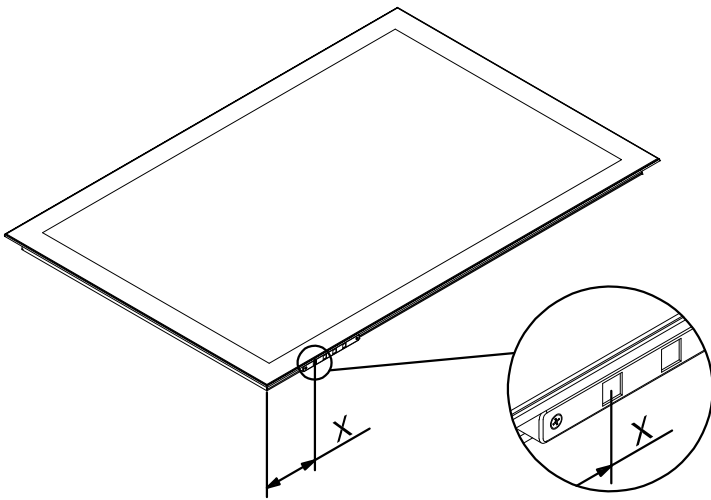

S9212---



S9212--RA---



S9212--BT---



S9212--RABT--

S9212---

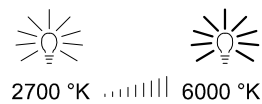
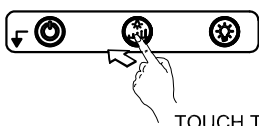
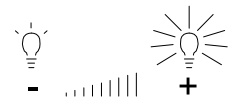
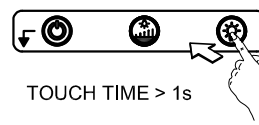
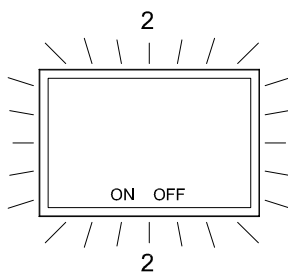
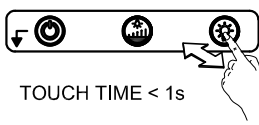
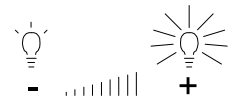
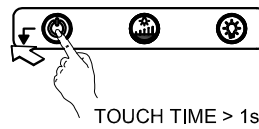
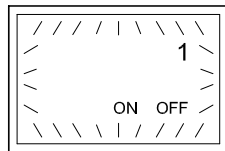
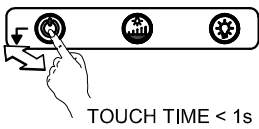

S9212--RA---

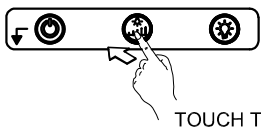
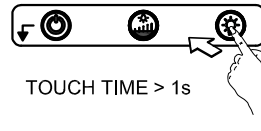
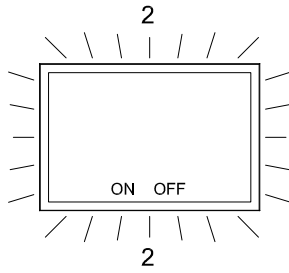
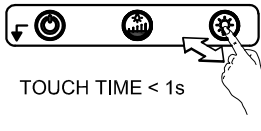
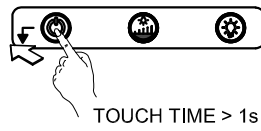
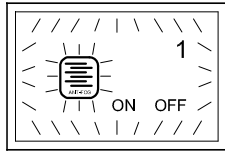
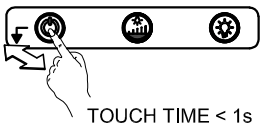

S9212--BT---

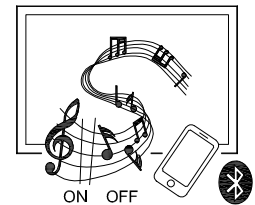
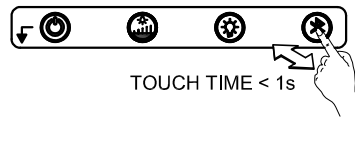
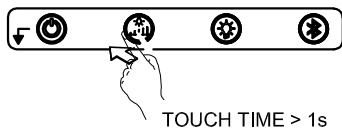
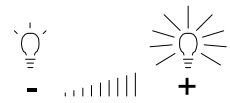
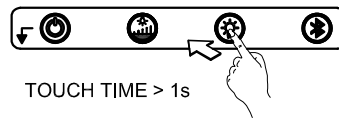
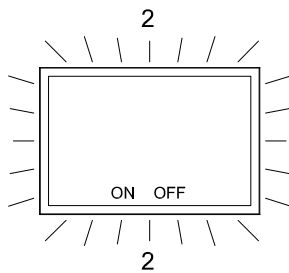
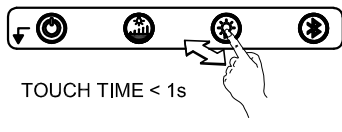
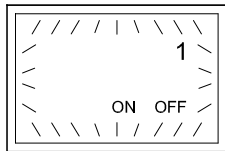
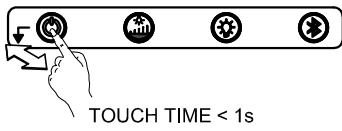

S9212--RABT--

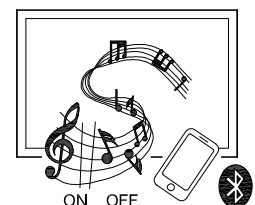
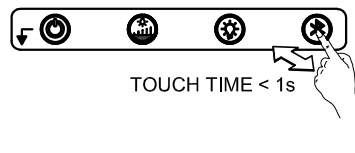
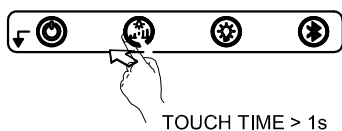
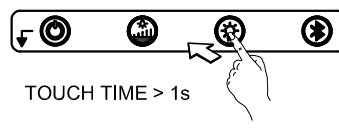
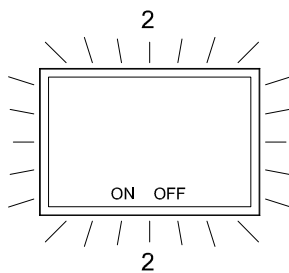
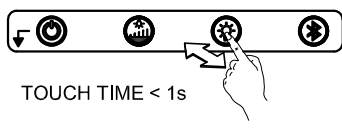
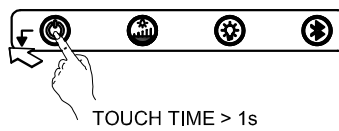
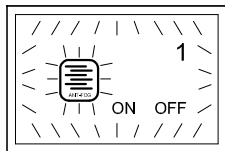
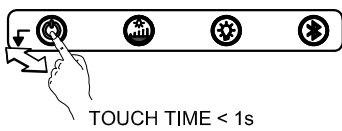

S9813

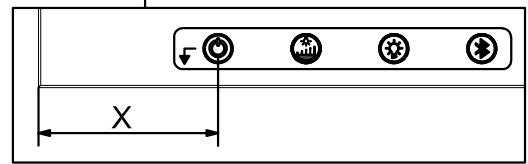
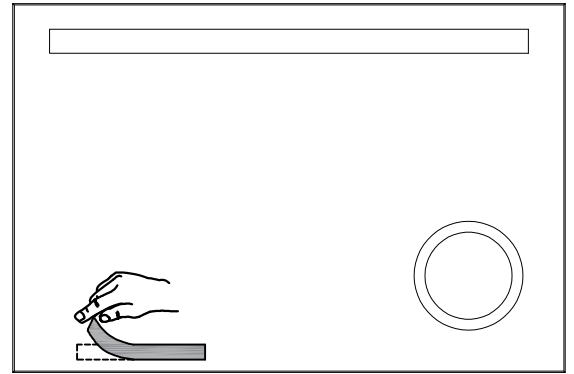
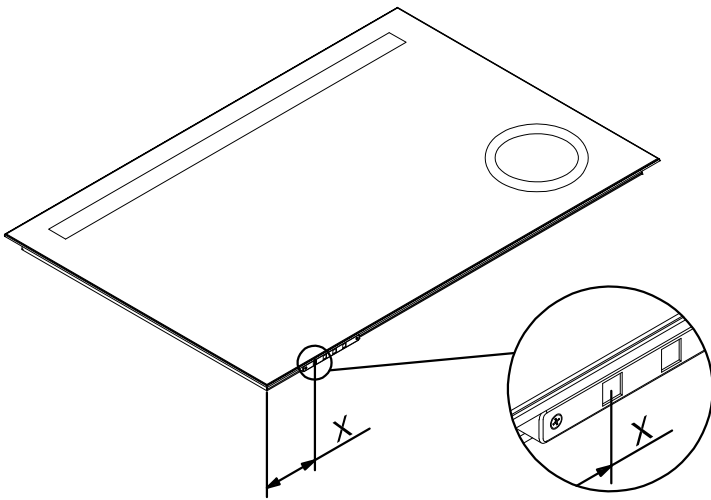

S9813---



S9813--RA---

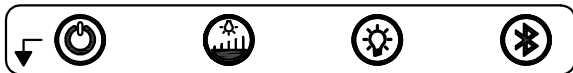

S9813--BT---



S9813--RABT--

S9813---



TOUCH TIME < 1s

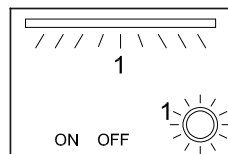

TOUCH TIME > 1s



TOUCH TIME < 1s

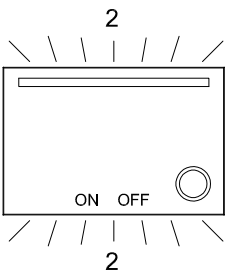

TOUCH TIME > 1s

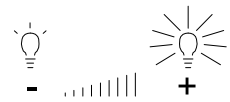

TOUCH TIME > 1s



S9813--RA---

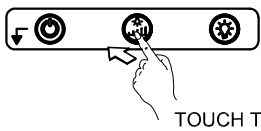
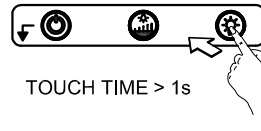
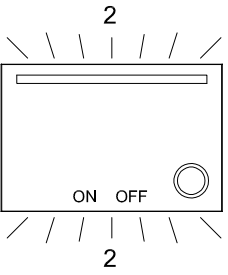
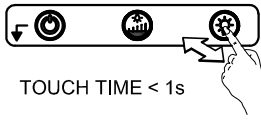
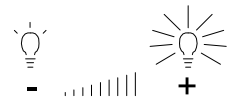
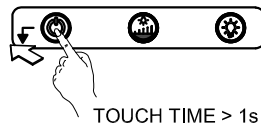
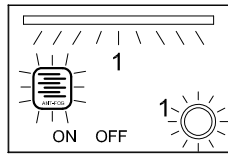
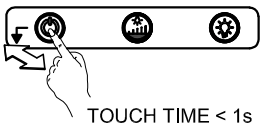

S9813--BT---

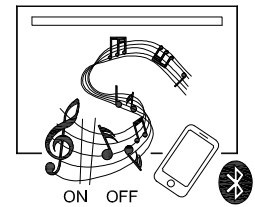
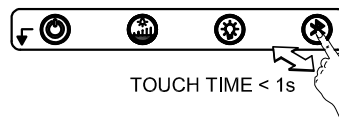
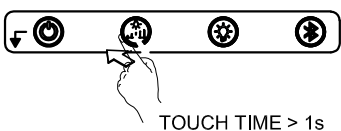
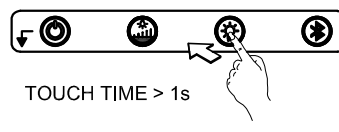
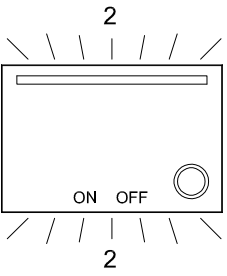
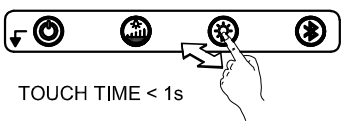
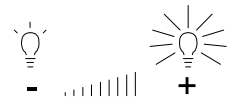
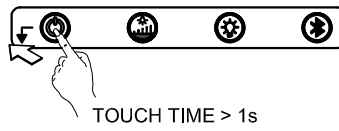
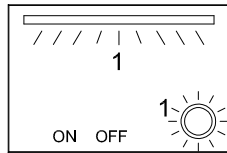
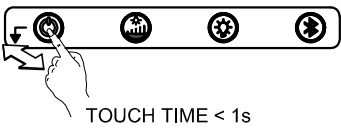

S9813--RABT--

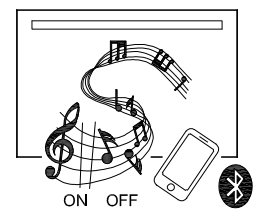
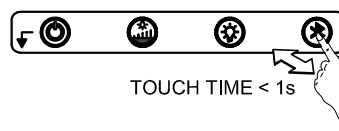
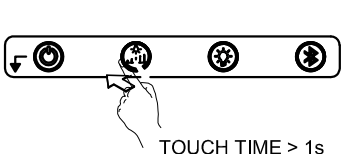
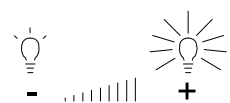
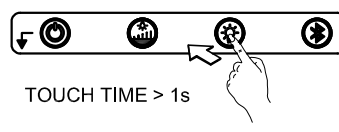
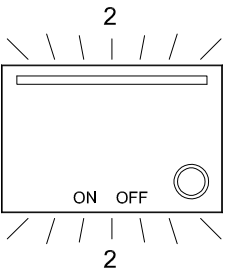
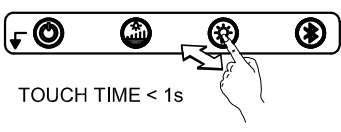
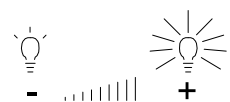
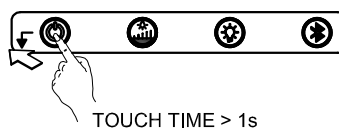
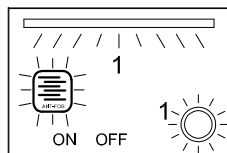
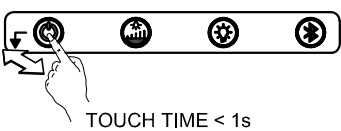

S9312

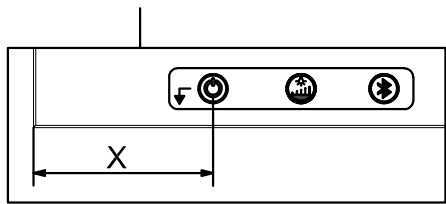
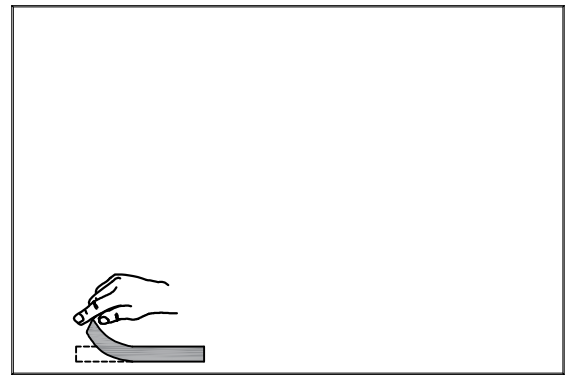
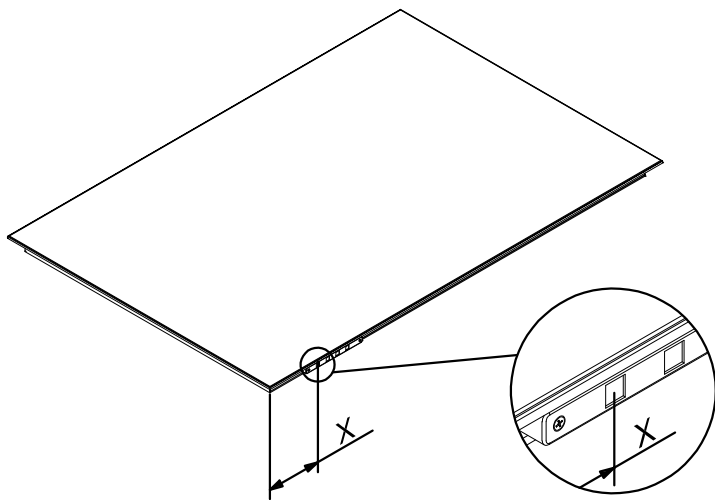

S9312---



S9312--RA---



S9312--BT---



S9312--RABT--

S9312---

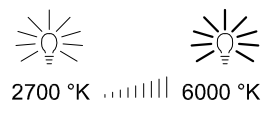
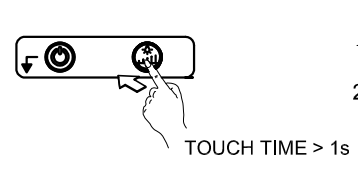
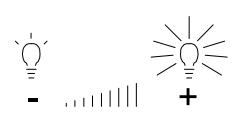
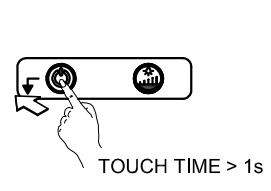
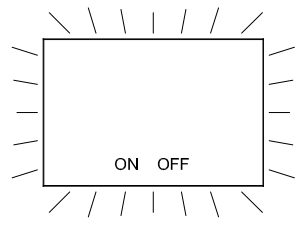
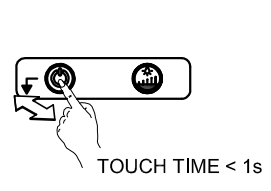

S9312--RA---

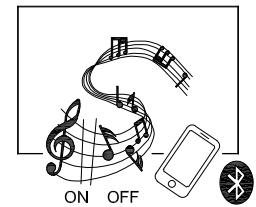
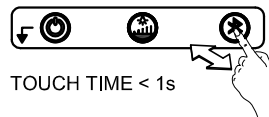
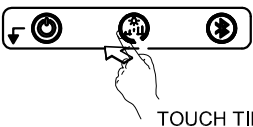
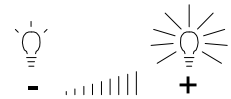
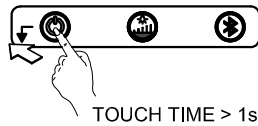
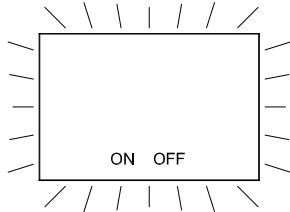
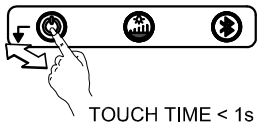
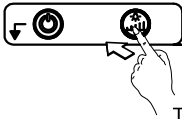
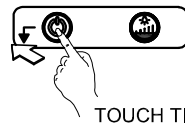
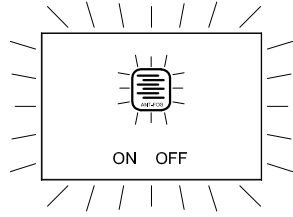
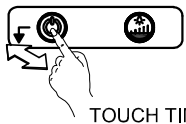

S9312--RABT--

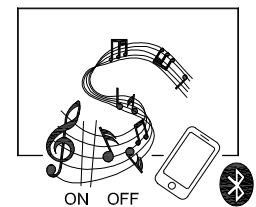
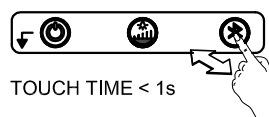
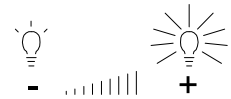
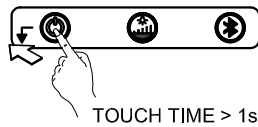
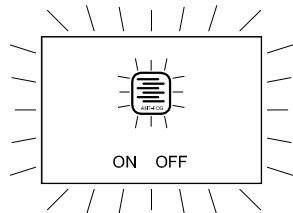
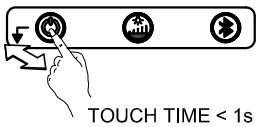

S9212

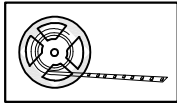
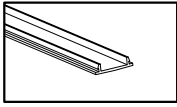
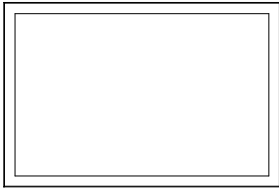

S921210	RMOB00000041	S921210	RMOB00000125
S921215	RMOB00000042	S921215	RMOB00000126
S921220	RMOB00000043	S921220	RMOB00000127
S921225	RMOB00000044	S921225	RMOB00000128
S921230	RMOB00000045	S921230	RMOB00000129
S921235	RMOB00000046	S921235	RMOB00000130
S921240	RMOB00000047	S921240	RMOB00000131
S921245	RMOB00000048	S921245	RMOB00000132
S921250	RMOB00000049	S921250	RMOB00000133
S921260	RMOB00000050	S921260	RMOB00000134
S921270	RMOB00000051	S921270	RMOB00000135
S921280	RMOB00000052	S921280	RMOB00000136

S9312

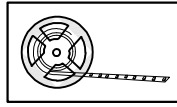
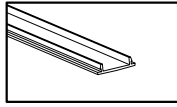

S931210	RMOB00000077	S931210	RMOB00000161
S931215	RMOB00000078	S931215	RMOB00000162
S931220	RMOB00000079	S931220	RMOB00000163
S931225	RMOB00000080	S931225	RMOB00000164
S931230	RMOB00000081	S931230	RMOB00000165
S931235	RMOB00000082	S931235	RMOB00000166
S931240	RMOB00000083	S931240	RMOB00000167
S931245	RMOB00000084	S931245	RMOB00000168
S931250	RMOB00000085	S931250	RMOB00000169
S931260	RMOB00000086	S931260	RMOB00000170
S931270	RMOB00000087	S931270	RMOB00000171
S931280	RMOB00000088	S931280	RMOB00000172

S9114

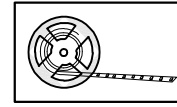
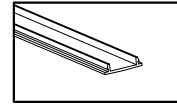
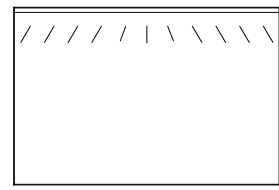

S911410	RMOB00000089	S911410	RMOB00000185
S911415	RMOB00000090	S911415	RMOB00000186
S911420	RMOB00000091	S911420	RMOB00000187
S911425	RMOB00000092	S911425	RMOB00000188
S911430	RMOB00000093	S911430	RMOB00000189
S911435	RMOB00000094	S911435	RMOB00000190
S911440	RMOB00000095	S911440	RMOB00000191
S911445	RMOB00000096	S911445	RMOB00000192
S911450	RMOB00000097	S911450	RMOB00000193
S911460	RMOB00000098	S911460	RMOB00000194
S911470	RMOB00000099	S911470	RMOB00000195
S911480	RMOB00000100	S911480	RMOB00000196

S9712

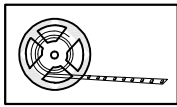
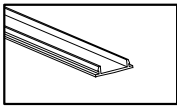
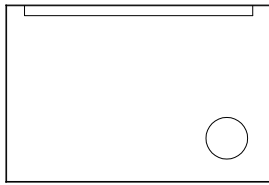

S971210	RMOB00000101	S971210	RMOB00000209
S971215	RMOB00000102	S971215	RMOB00000210
S971220	RMOB00000103	S971220	RMOB00000211
S971225	RMOB00000104	S971225	RMOB00000212
S971230	RMOB00000105	S971230	RMOB00000213
S971235	RMOB00000106	S971235	RMOB00000214
S971240	RMOB00000107	S971240	RMOB00000215
S971245	RMOB00000108	S971245	RMOB00000216
S971250	RMOB00000109	S971250	RMOB00000217
S971260	RMOB00000110	S971260	RMOB00000218
S971270	RMOB00000111	S971270	RMOB00000219
S971280	RMOB00000112	S971280	RMOB00000220

S9612

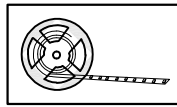
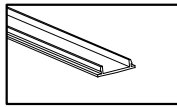
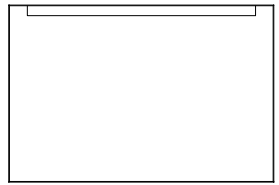

S961210	RMOB00000101	S961210	RMOB00000209
S961215	RMOB00000102	S961215	RMOB00000210
S961220	RMOB00000103	S961220	RMOB00000211
S961225	RMOB00000104	S961225	RMOB00000212
S961230	RMOB00000105	S961230	RMOB00000213
S961235	RMOB00000106	S961235	RMOB00000214
S961240	RMOB00000107	S961240	RMOB00000215
S961245	RMOB00000108	S961245	RMOB00000216
S961250	RMOB00000109	S961250	RMOB00000217
S961260	RMOB00000110	S961260	RMOB00000218
S961270	RMOB00000111	S961270	RMOB00000219
S961280	RMOB00000112	S961280	RMOB00000220

S9512

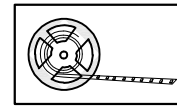
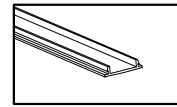
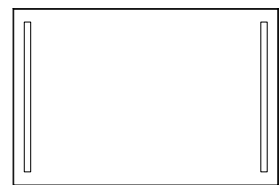

S951210	RMOB00000053	S951210	RMOB00000222
S951215	RMOB00000054	S951215	RMOB00000223
S951220	RMOB00000055	S951220	RMOB00000224
S951225	RMOB00000056	S951225	RMOB00000225
S951230	RMOB00000057	S951230	RMOB00000226
S951235	RMOB00000058	S951235	RMOB00000227
S951240	RMOB00000059	S951240	RMOB00000228
S951245	RMOB00000060	S951245	RMOB00000229
S951250	RMOB00000061	S951250	RMOB00000230
S951260	RMOB00000062	S951260	RMOB00000231
S951270	RMOB00000063	S951270	RMOB00000232
S951280	RMOB00000064	S951280	RMOB00000233

S9813

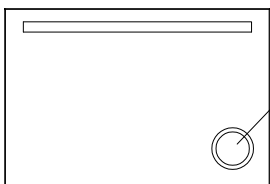

RMOB00000259

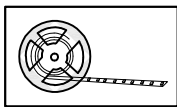
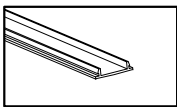

S981310	RMOB00000053	S981310	RMOB00000246
S981315	RMOB00000054	S981315	RMOB00000247
S981320	RMOB00000055	S981320	RMOB00000248
S981325	RMOB00000056	S981325	RMOB00000249
S981330	RMOB00000057	S981330	RMOB00000250
S981335	RMOB00000058	S981335	RMOB00000251
S981340	RMOB00000059	S981340	RMOB00000252
S981345	RMOB00000060	S981345	RMOB00000253
S981350	RMOB00000061	S981350	RMOB00000254
S981360	RMOB00000062	S981360	RMOB00000255
S981370	RMOB00000063	S981370	RMOB00000256
S981380	RMOB00000064	S981380	RMOB00000257

S9412

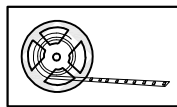
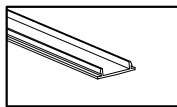

S941310	RMOB00000053	S941310	RMOB00000246
S941315	RMOB00000054	S941315	RMOB00000247
S941320	RMOB00000055	S941320	RMOB00000248
S941325	RMOB00000056	S941325	RMOB00000249
S941330	RMOB00000057	S941330	RMOB00000250
S941335	RMOB00000058	S941335	RMOB00000251
S941340	RMOB00000059	S941340	RMOB00000252
S941345	RMOB00000060	S941345	RMOB00000253
S941350	RMOB00000061	S941350	RMOB00000254
S941360	RMOB00000062	S941360	RMOB00000255
S941370	RMOB00000063	S941370	RMOB00000256
S941380	RMOB00000064	S941380	RMOB00000257

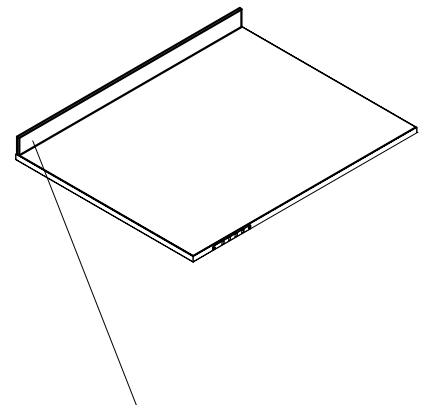

S911410	RMOB00000262
S911415	RMOB00000263
S911420	RMOB00000264
S911425	RMOB00000265
S911430	RMOB00000266
S911435	RMOB00000267
S911440	RMOB00000268
S911445	RMOB00000269
S911450	RMOB00000270
S911460	RMOB00000271
S911470	RMOB00000272
S911480	RMOB00000273

S94-95-96-97-98
RMOB00000260

2x



2x

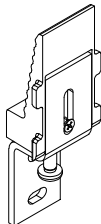

S91-92-9312
RMOB00000261

2x



2x

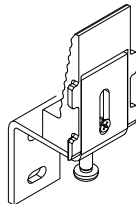

RMOB00000033 50W 12V
RMOB000000274 15W 24V
RMOB000000034 30W 24V
RMOB000000035 60W 24V
RMOB000000036 100W 24V
RMOB000000275 150W 24V

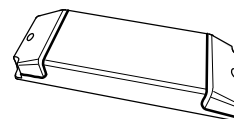

S9114 S9212 RMOB00000278

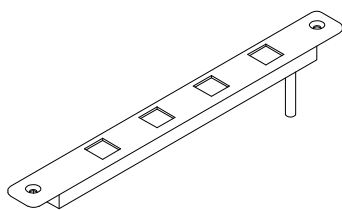
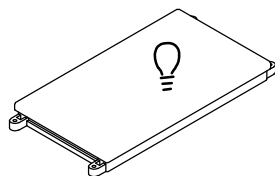

S9312 RMOB00000279
S94-95-96-97-98 RMOB00000280

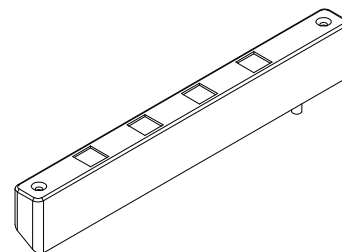
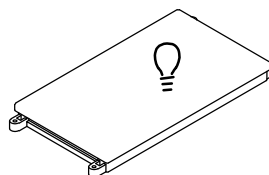

RMOB00000285

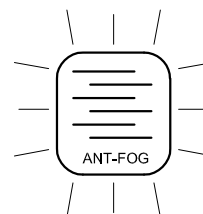
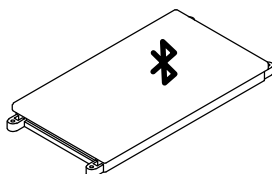
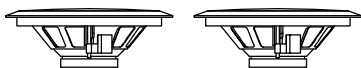

450x350
500x500
730x430
1100x440

RMOB00000281
RMOB00000282
RMOB00000283
RMOB00000284

S9610 / S9710
RMOB00000286

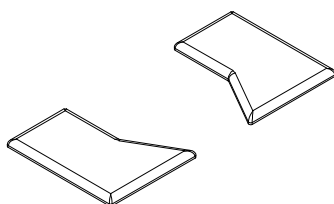

- GB** 24-MONTH WARRANTY: general conditions. ATTENTION: please keep a fiscal purchase document(receipt,bill, invoice etc.) together with this manual
- I** GARANZIA DI 24 MESI: condizioni generali. ATTENZIONE: conservare con questo fascicolo un documento fiscale d'acquisto (scontrino fiscale,bolla d'accompagnamento, fattura ecc.)
- F** GARANTIE DE 24 MOIS: conditions générales. ATTENTION: conserver avec ce dossier un document officiel d'achat (remise fiscale,bordereau de livraison,facture etc.)
- D** GARANTIE VON 24 MONATEN: Allgem.Konditionen. ACHTUNG: Mit diesem Heft bitte auch eine Quittung aufbewahren (Kassenzettel,Lieferschein,Rechnung etc.)
- NL** GARANTIE VAN 24 MAANDEN: algemene voorwaarden OPGELET: bewaar bij dit boekje een fiscaal document van aankoop (kassabon,faktuur etc.)
- E** GARANTÍA DE 24 MESES: condiciones generales ADVERTENCIA: Junto con este folleto, consérvese el justificante de compra (recibo,albarán,factura,etc.).

