

YOUR
OWN
STYLE

WALK IN

Free space.



H200

6mm

8mm

Finiture / Finishes / Acabados / Finitions / Afwerkingen / Ausführungen

Telaio / Frame / Bastidor / Profilé / Frame / Rahmen

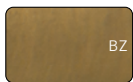
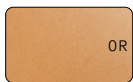
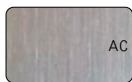
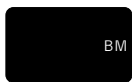

Vetro / Glass / Vidrio / Verre / Glas / Glas

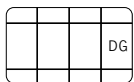
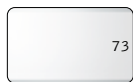
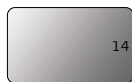
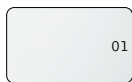

Modelli / Models / Modelos / Modèles / Modellen / Modelle

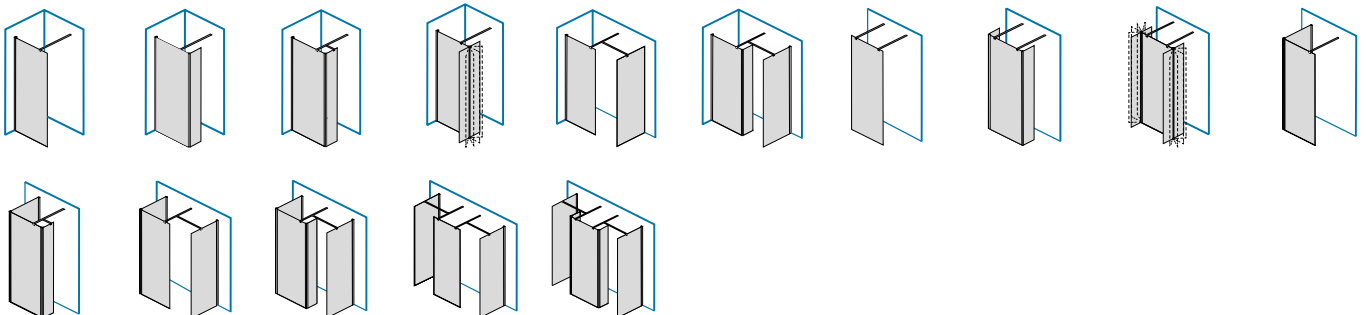

www.inda.net



Le dimensioni sono in mm / Sizes in mm /
 Les dimensions sont indiquées en mm /
 Las medidas son en mm /
 De afmetingen zijn vermeld in mm / Maßangaben in mm

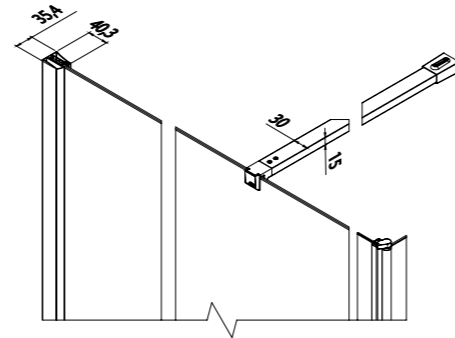
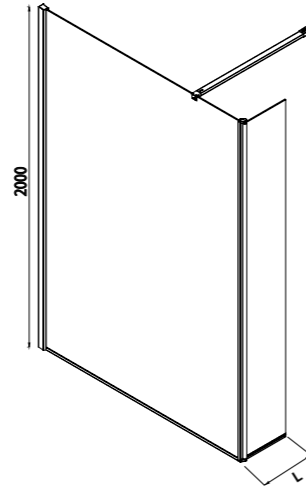

	AN	WM	BM	01	14
Larghezza - estensibilità Breadth - extensibility Largeur - extensibilité Composición - extensibilidad Breedte - aanpassingsvermogen Breite - Anpassungsfähigkeit				cod.	cod.
L 30 cm				B2561 M AN 01 B2561 M WM 01 B2561 M BM 01	B2561 M AN 14 B2561 M WM 14 B2561 M BM 14
L 40 cm				B2562 M AN 01 B2562 M WM 01 B2562 M BM 01	B2562 M AN 14 B2562 M WM 14 B2562 M BM 14
L 50 cm				B2563 M AN 01 B2563 M WM 01 B2563 M BM 01	B2563 M AN 14 B2563 M WM 14 B2563 M BM 14

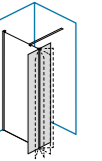

deflettore M + parete A
 deflector M + panel A
 deflettore M + paroi A
 deflector M + pared A
 deflektor + Wand A

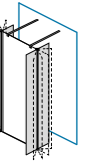

deflettore M + parete A
 deflector M + panel A
 deflettore M + paroi A
 deflector M + pared A
 deflektor + Wand A

Vetro temperato di sicurezza 6 mm.
 Il movimento di rotazione 270° viene garantito mediante sistema Camme integrato.
 Tempered safety glass 6 mm.
 The 270° round moving is guaranteed with integrated Camme-System.
 Verre trempé de sécurité 6 mm.
 Le mouvement de rotation 270° est garanti grâce au système à Came intégré.
 Vidrio templado de seguridad 6 mm.
 Se garantiza el movimiento de rotación 270° a través de un sistema Camme integrado.
 Gehard zekerheidsglas 6 mm. De 270° roterende beweging wordt gegarandeerd door het geïntegreerde Camme systeem.
 Sicherheitsglas 6 mm. Die 270° Drehung ist gewährleistet dank einer integrierten Nockenkupplung.

L	KG	
30 cm	10	1
40 cm	11	1
50 cm	12	1