

YOUR
OWN
STYLE

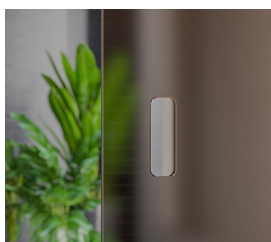

WALK IN COULISSANTE

Sliding door.



H200

6mm

8mm

Finiture / Finishes / Acabados / Finitions / Afwerkingen / Ausführungen

Telaio / Frame / Bastidor / Profilé / Frame / Rahmen

Vetro / Glass / Vidrio / Verre / Glas / Glas

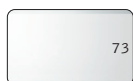
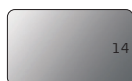
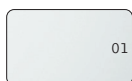
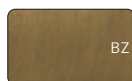
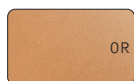
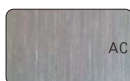

Modelli / Models / Modelos / Modèles / Modellen / Modelle

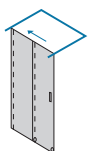
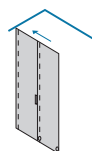
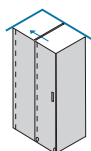

www.inda.net

 **inda**[®]
bathroom interiors

WALK IN_COULISSANTE

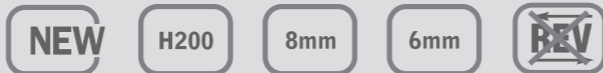

Walk-in scorrevole sinistra / Walk-in left sliding door
Walk-in coulissante gauche / Walk-in corredera izquierda
Linker schuifdeur / Linke Schiebetür

H max 217 cm
L min 50 cm max 190 cm



Le dimensioni sono in mm / Sizes in mm /
Les dimensions sont indiquées en mm /
Las medidas son en mm /
De afmetingen zijn vermeld in mm / Maßangaben in mm

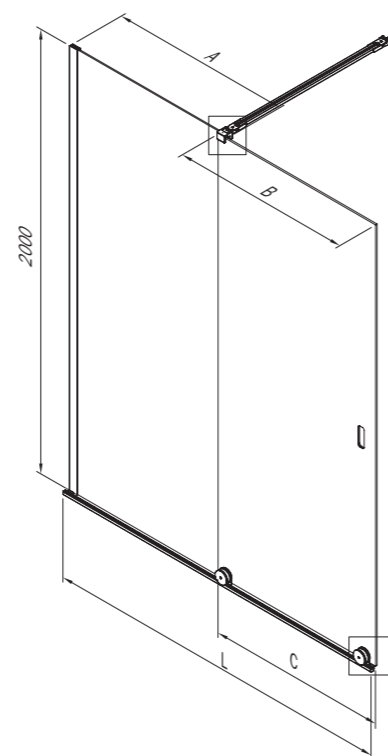
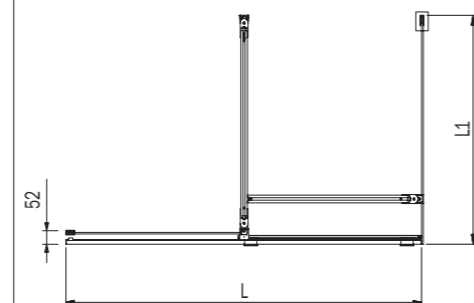

Porta scorrevole 8 mm, parete fissa 6 mm, maniglia M3.
8mm sliding door, 6mm fixed panel, M3 handle.
Porte coulissante 8 mm, panneau fixe 6 mm, poignée M3.
Puerta corredera de 8 mm, panel fijo de 6 mm, tirador M3.
8 mm schuifdeur, 6 mm vaste wand, M3 handvat.
Schiebetür 8mm, Feste Wand 6 mm, Griff M3.

L	A	B	C	KG	
98 - 100	52,3	51,7	46	50	2
100 - 110	57,3	56,7	51	55	2
110 - 120	62,3	61,7	56	60	2
120 - 140	72,3	71,7	66	67	2
140 - 160	82,3	81,7	76	76	2
160 - 180	92,3	91,7	86	84	2
L1 PARETE FISSA / FIXED PANEL					
68 - 70				36	1
78 - 80				41	1
88 - 90				46	1
98 - 100				50	1

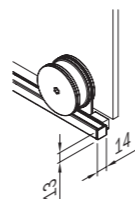
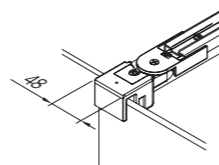

AN WM BM AC OR BZ	01	14	73	41
Larghezza - estensibilità Breadth - extensibility Largeur - extensibilité Composición - extensibilidad Breedte - aanpassingsvermogen Breite - Anpassungsfähigkeit	cod.	cod.	cod.	cod.
L 98 - 100 cm	B2520 0 AN 01	B2520 0 AN 14	B2520 S AN 73	B2520 S AN 41
WM - BM	B2520 0 01	B2520 0 14	B2520 S 73	B2520 S 41
AC - OR - BZ	B2520 0 01	B2520 0 14	B2520 S 73	B2520 S 41
L 100 - 110 cm	B2521 0 AN 01	B2521 0 AN 14	B2521 S AN 73	B2521 S AN 41
WM - BM	B2521 0 01	B2521 0 14	B2521 S 73	B2521 S 41
AC - OR - BZ	B2521 0 01	B2521 0 14	B2521 S 73	B2521 S 41
L 110 - 120 cm	B2522 0 AN 01	B2522 0 AN 14	B2522 S AN 73	B2522 S AN 41
WM - BM	B2522 0 01	B2522 0 14	B2522 S 73	B2522 S 41
AC - OR - BZ	B2522 0 01	B2522 0 14	B2522 S 73	B2522 S 41
L 120 - 140 cm	B2523 0 AN 01	B2523 0 AN 14	B2523 S AN 73	B2523 S AN 41
WM - BM	B2523 0 01	B2523 0 14	B2523 S 73	B2523 S 41
AC - OR - BZ	B2523 0 01	B2523 0 14	B2523 S 73	B2523 S 41
L 140 - 160 cm	B2524 0 AN 01	B2524 0 AN 14	B2524 S AN 73	B2524 S AN 41
WM - BM	B2524 0 01	B2524 0 14	B2524 S 73	B2524 S 41
AC - OR - BZ	B2524 0 01	B2524 0 14	B2524 S 73	B2524 S 41
L 160 - 180 cm	B2525 0 AN 01	B2525 0 AN 14	B2525 S AN 73	B2525 S AN 41
WM - BM	B2525 0 01	B2525 0 14	B2525 S 73	B2525 S 41
AC - OR - BZ	B2525 0 01	B2525 0 14	B2525 S 73	B2525 S 41

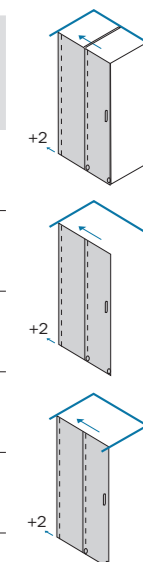

Parete fissa per combinazione ad angolo / Fixed panel for angle combination
Paroi fixe pour combinaison en angle / Pared fija para combinación de esquina
Vaste wand voor hoekcombinaties / Feste Wand für Kombinationen

H max 217 cm
L min 30 cm max 110 cm

Larghezza - estensibilità Breadth - extensibility Largeur - extensibilité Composición - extensibilidad Breedte - aanpassingsvermogen Breite - Anpassungsfähigkeit	cod.	cod.	cod.	cod.
L 68 - 70 cm	B2590 F AN 01	B2590 F AN 14	B2590 F AN 73	B2590 F AN 41
WM - BM	B2590 F 01	B2590 F 14	B2590 F 73	B2590 F 41
AC - OR - BZ	B2590 F 01	B2590 F 14	B2590 F 73	B2590 F 41
L 78 - 80 cm	B2591 F AN 01	B2591 F AN 14	B2591 F AN 73	B2591 F AN 41
WM - BM	B2591 F 01	B2591 F 14	B2591 F 73	B2591 F 41
AC - OR - BZ	B2591 F 01	B2591 F 14	B2591 F 73	B2591 F 41
L 88 - 90 cm	B2592 F AN 01	B2592 F AN 14	B2592 F AN 73	B2592 F AN 41
WM - BM	B2592 F 01	B2592 F 14	B2592 F 73	B2592 F 41
AC - OR - BZ	B2592 F 01	B2592 F 14	B2592 F 73	B2592 F 41
L 98 - 100 cm	B2593 F AN 01	B2593 F AN 14	B2593 F AN 73	B2593 F AN 41
WM - BM	B2593 F 01	B2593 F 14	B2593 F 73	B2593 F 41
AC - OR - BZ	B2593 F 01	B2593 F 14	B2593 F 73	B2593 F 41

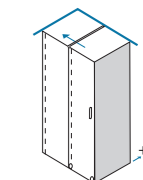

Maniglie
Handles
Poignées
Tiradores
Handvat
Griff

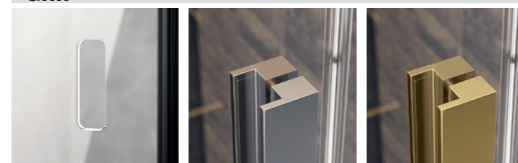

STANDARD M3 ... AN BM WM M3 ... AC OR BZ

Barra
Bar
Barre
Barra
Staafl
Leiste



B0080A AN BM WM AC OR BZ BKT251 CR BM WM AC OR BZ BKT252 CR BM WM AC OR BZ

Kit chiusura magnetica
Magnetic closure kit
Kit de fermeture magnétique
Kit de cierre magnético
Magnetische sluitingskit
Magnetverschluss Set



B0081 CR BM WM AC OR BZ

WALK IN_COULISSANTE

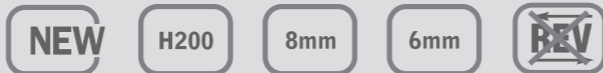

Walk-in scorrevole destra / Walk-in right sliding door
Walk-in coulissante droite / Walk-in puerta corredera derecha
Rechter schuifdeur / Rechte Drehtür

H max 217 cm
L min 50 cm max 190 cm



Porta scorrevole 8 mm, parete fissa 6 mm, maniglia standard.
8mm sliding door, 6mm fixed panel, standard handle.
Porte coulissante 8 mm, panneau fixe 6 mm, poignée standard.
Puerta corredera de 8 mm, panel fijo de 6 mm, tirador estándar.
8 mm schuifdeur, 6 mm vaste wand, standaard handvat.
Puerta corredera de 8 mm, panel fijo de 6 mm, tirador estándar.

Le dimensioni sono in mm / Sizes in mm /
Les dimensions sont indiquées en mm /
Las medidas son en mm /
De afmetingen zijn vermeld in mm / Maßangaben in mm

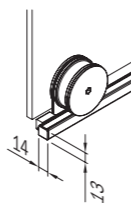
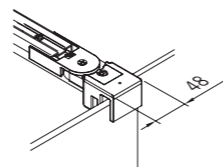
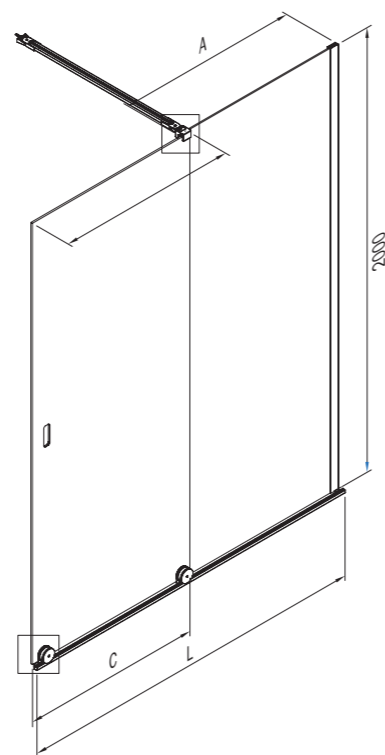
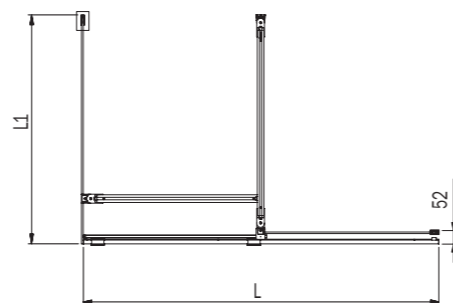

L	A	B	C	KG	
98 - 100	52,3	51,7	46	50	2
100 - 110	57,3	56,7	51	55	2
110 - 120	62,3	61,7	56	60	2
120 - 140	72,3	71,7	66	67	2
140 - 160	82,3	81,7	76	76	2
160 - 180	92,3	91,7	86	84	2
L1 PARETE FISSA / FIXED PANEL					
68 - 70				36	1
78 - 80				41	1
88 - 90				46	1
98 - 100				50	1



AN WM BM AC OR BZ	01	14	73	41
Larghezza - estensibilità Breadth - extensibility Largeur - extensibilité Composición - extensibilidad Breedte - aanpassingsvermogen Breite - Anpassungsfähigkeit	cod.	cod.	cod.	cod.
L 98 - 100 cm	B2520 0 AN 01	B2520 0 AN 14	B2520 D AN 73	B2520 D AN 41
WM - BM	B2520 0 01	B2520 0 14	B2520 D 73	B2520 D 41
AC - OR - BZ	B2520 0 01	B2520 0 14	B2520 D 73	B2520 D 41
L 100 - 110 cm	B2521 0 AN 01	B2521 0 AN 14	B2521 D AN 73	B2521 D AN 41
WM - BM	B2521 0 01	B2521 0 14	B2521 D 73	B2521 D 41
AC - OR - BZ	B2521 0 01	B2521 0 14	B2521 D 73	B2521 D 41
L 110 - 120 cm	B2522 0 AN 01	B2522 0 AN 14	B2522 D AN 73	B2522 D AN 41
WM - BM	B2522 0 01	B2522 0 14	B2522 D 73	B2522 D 41
AC - OR - BZ	B2522 0 01	B2522 0 14	B2522 D 73	B2522 D 41
L 120 - 140 cm	B2523 0 AN 01	B2523 0 AN 14	B2523 D AN 73	B2523 D AN 41
WM - BM	B2523 0 01	B2523 0 14	B2523 D 73	B2523 D 41
AC - OR - BZ	B2523 0 01	B2523 0 14	B2523 D 73	B2523 D 41
L 140 - 160 cm	B2524 0 AN 01	B2524 0 AN 14	B2524 D AN 73	B2524 D AN 41
WM - BM	B2524 0 01	B2524 0 14	B2524 D 73	B2524 D 41
AC - OR - BZ	B2524 0 01	B2524 0 14	B2524 D 73	B2524 D 41
L 160 - 180 cm	B2525 0 AN 01	B2525 0 AN 14	B2525 D AN 73	B2525 D AN 41
WM - BM	B2525 0 01	B2525 0 14	B2525 D 73	B2525 D 41
AC - OR - BZ	B2525 0 01	B2525 0 14	B2525 D 73	B2525 D 41

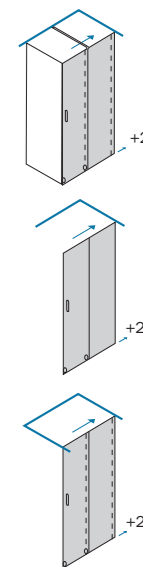

Parete fissa per combinazione ad angolo / Fixed panel for angle combination
Paroi fixe pour combinaison en angle / Pared fija para combinación de esquina
Vaste wand voor hoekcombinaties / Feste Wand für Kombinationen

H max 217 cm
L min 30 cm max 110 cm

Larghezza - estensibilità Breadth - extensibility Largeur - extensibilité Composición - extensibilidad Breedte - aanpassingsvermogen Breite - Anpassungsfähigkeit	cod.	cod.	cod.	cod.
L 68 - 70 cm	B2590 F AN 01	B2590 F AN 14	B2590 F AN 73	B2590 F AN 41
WM - BM	B2590 F 01	B2590 F 14	B2590 F 73	B2590 F 41
AC - OR - BZ	B2590 F 01	B2590 F 14	B2590 F 73	B2590 F 41
L 78 - 80 cm	B2591 F AN 01	B2591 F AN 14	B2591 F AN 73	B2591 F AN 41
WM - BM	B2591 F 01	B2591 F 14	B2591 F 73	B2591 F 41
AC - OR - BZ	B2591 F 01	B2591 F 14	B2591 F 73	B2591 F 41
L 88 - 90 cm	B2592 F AN 01	B2592 F AN 14	B2592 F AN 73	B2592 F AN 41
WM - BM	B2592 F 01	B2592 F 14	B2592 F 73	B2592 F 41
AC - OR - BZ	B2592 F 01	B2592 F 14	B2592 F 73	B2592 F 41
L 98 - 100 cm	B2593 F AN 01	B2593 F AN 14	B2593 F AN 73	B2593 F AN 41
WM - BM	B2593 F 01	B2593 F 14	B2593 F 73	B2593 F 41
AC - OR - BZ	B2593 F 01	B2593 F 14	B2593 F 73	B2593 F 41

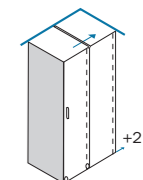

Maniglie
Handles
Poignées
Tiradores
Handvat
Griff

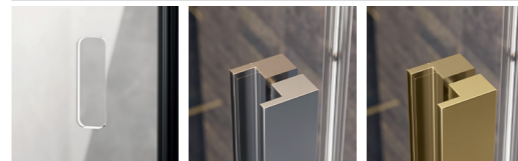

STANDARD M3 ... AN BM WM M3 ... AC OR BZ

Barra
Bar
Barre
Barra
Staaft
Leiste



B0080A AN BM WM AC OR BZ BKT251 CR BM WM AC OR BZ BKT252 CR BM WM AC OR BZ

Kit chiusura magnetica
Magnetic closure kit
Kit de fermeture magnétique
Kit de cierre magnético
Magnetische sluitingskit
Magnetverschluss Set



B0081 CR BM WM AC OR BZ

WALK IN_COULISSANTE

Le dimensioni sono in mm / Sizes in mm /
Les dimensions sont indiquées en mm /
Las medidas son en mm /
De afmetingen zijn vermeld in mm / Maßangaben in mm

